

ChandJee Mfg. Co.

**SURGICAL
TC. INSERTS**

ALPHABATICAL

INDEX

SURGICAL INSTRUMENTS

T.C. INSTRUMENTS

DENTAL INSTRUMENTS

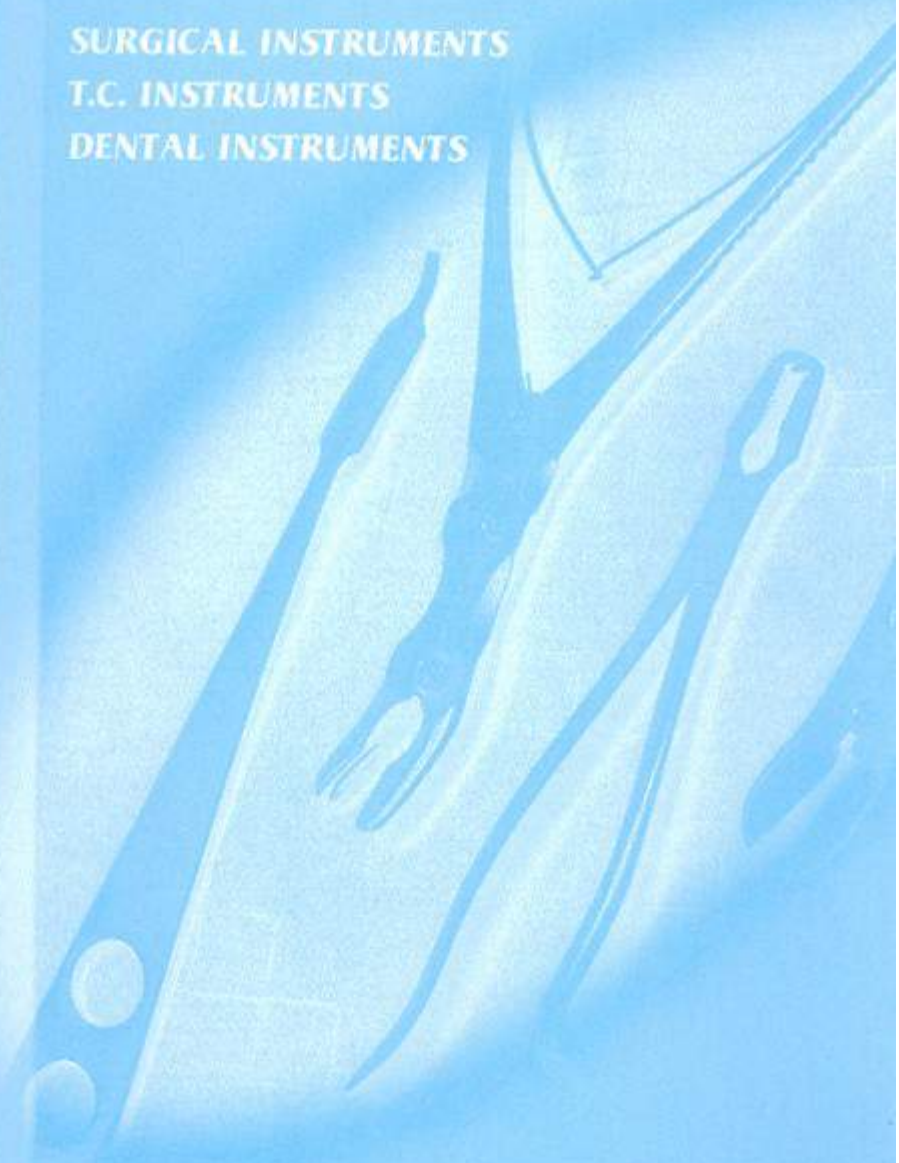

*20 years of experience
always in moderate quality,
now certified with*

ISO 9002

cGMP

CE

About Us

*CHANDJEE MFG. CO. was established in 1977,
with its Headquarter in Sialkot,
the town which is known for the skill
in manufacturing of high Quality Surgical Instruments.
With all the modern In-House manufacturing facilities,
we offer the Best Quality Surgical, Dental, Veterinary
Instruments, Scissors and Hand Tool Pliers.
We are serving our valuable customers, since last two
decades and have got pretty good reputation for
High Quality and competitive prices.*

ChandJee Mfg. co.

P.O.Box: 1255
Jinnah Islamia College Road,
Sialkot-51310 Pakistan.

Ph: 92 52 4593589

92 52 4580589

Fax: 92 52 4269044

E-mail: chand@chandjee.com.pk

www.chandjee.com.pk



SCALPLE HANDLE



Standard
C-1001



C-1002



C-1003



C-1004



C-1005



C-1006



C-1007

Chand Jee



DISSECTING AND FINE OPERATING SCISSORS

Surgical Instruments



Standard
C-1008
to
C-1015



Str

- C-1008 (10.5 cm)
- C-1009 (11.5 cm)
- C-1010 (13.5 cm)
- C-1011 (14.5 cm)
- C-1012 (15.5 cm)
- C-1013 (16.5 cm)
- C-1014 (18.5 cm)
- C-1015 (20.5 cm)



Standard
C-1016
to
C-1022



Cur

- C-1016 (11.5 cm)
- C-1017 (13.5 cm)
- C-1018 (14.5 cm)
- C-1019 (15.5 cm)
- C-1020 (16.5 cm)
- C-1021 (18.5 cm)
- C-1022 (20.5 cm)



Standard
C-1023
to
C-1030



Str

- C-1023 (10.5 cm)
- C-1024 (11.5 cm)
- C-1025 (13.5 cm)
- C-1026 (14.5 cm)
- C-1027 (15.5 cm)
- C-1028 (16.5 cm)
- C-1029 (18.5 cm)
- C-1030 (20.5 cm)



Standard
C-1031
to
C-1037



Cur

- C-1031 (11.5 cm)
- C-1032 (13.5 cm)
- C-1033 (14.5 cm)
- C-1034 (15.5 cm)
- C-1035 (16.5 cm)
- C-1036 (17.5 cm)
- C-1037 (18.5 cm)



OPERATING SCISSORS



Standard
C-1038
to
C-1045



Str

- C-1038 (10 cm)
- C-1039 (11 cm)
- C-1040 (13 cm)
- C-1041 (14 cm)
- C-1042 (15 cm)
- C-1043 (16 cm)
- C-1044 (18 cm)
- C-1045 (20 cm)



Standard
C-1046 to C-1053



Cur

- C-1046 (10 cm)
- C-1047 (11 cm)
- C-1048 (13 cm)
- C-1049 (14 cm)
- C-1050 (15 cm)
- C-1051 (16 cm)
- C-1052 (18 cm)
- C-1053 (20 cm)



Graziol
C-1054
to
C-1056

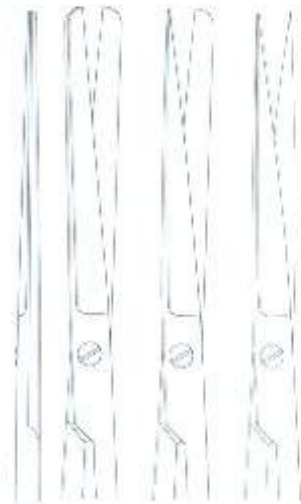

C-1054
14.5 cm

C-1055
14.5 cm

C-1056
14.5 cm



Graziol
C-1057
to
C-1059

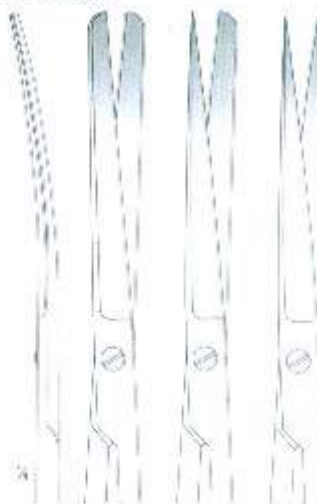

C-1057
14.5 cm

C-1058
14.5 cm

C-1059
14.5 cm



GYNECOLOGICAL SCISSORS

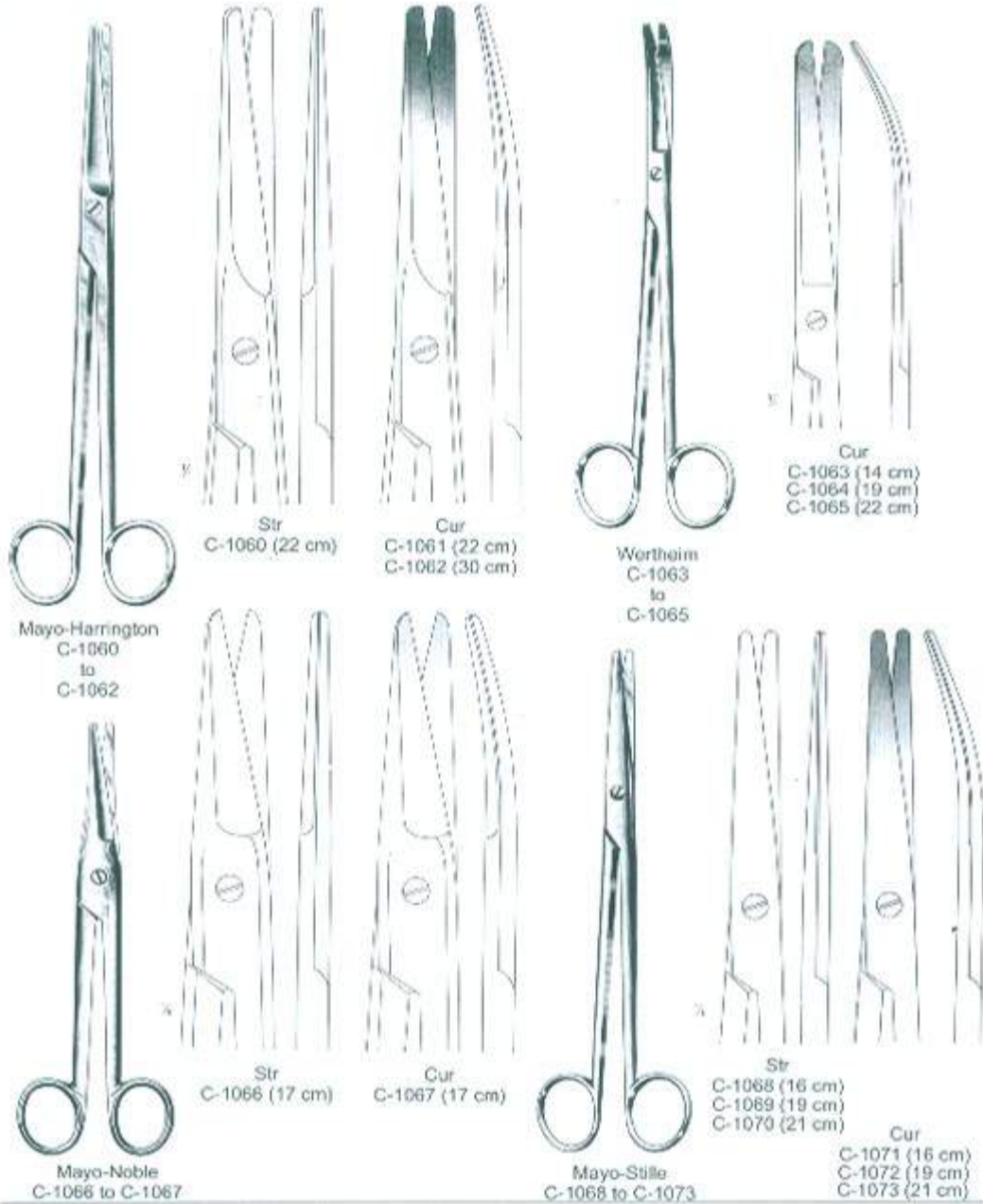



OPERATING AND DISSECTING SCISSORS

Surgical Instruments



Metzenbaum
C-1074
to
C-1075



Str
C-1074
(15 cm)



Cur
C-1075
(15 cm)



Metzenbaum
C-1076
to
C-1077



Str
C-1076
(11 cm)



Cur
C-1077
(11 cm)



Kelly
C-1078
to
C-1081



Str
C-1078
(16 cm)
C-1079
(18 cm)



Cur
C-1080
(16 cm)
C-1081
(18 cm)



Sims
C-1082 to C-1085



Str
C-1082 (20 cm)
C-1083 (23 cm)



Cur
C-1084 (20 cm)
C-1085 (23 cm)



DISSECTING SCISSORS

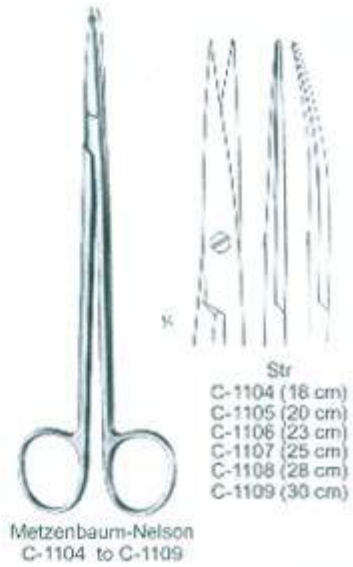



OPERATING SCISSORS





GUM AND MICRO SCISSORS

Surgical Instruments

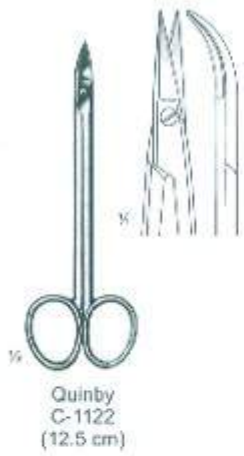

Quinby
C-1122
(12.5 cm)

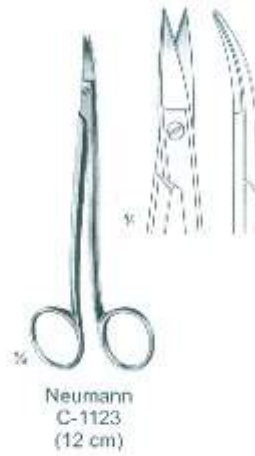

Neumann
C-1123
(12 cm)

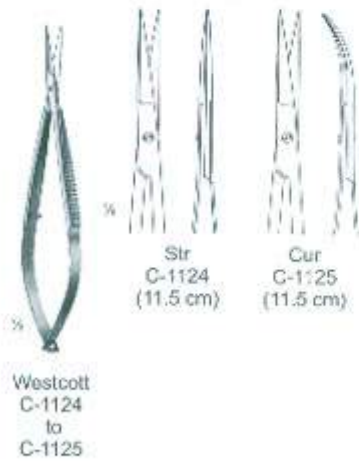

Westcott
C-1124
to
C-1125

Str
C-1124
(11.5 cm)

Cur
C-1125
(11.5 cm)

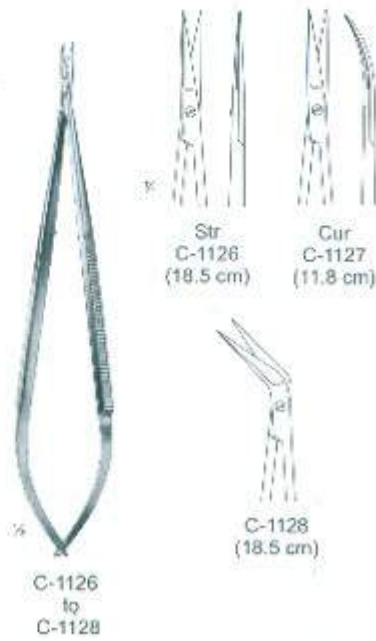

C-1126
to
C-1128

Str
C-1126
(18.5 cm)

Cur
C-1127
(11.8 cm)

C-1128
(18.5 cm)



LIGATURE WIRE CUTTING,
CROWN GUM SCISSORS

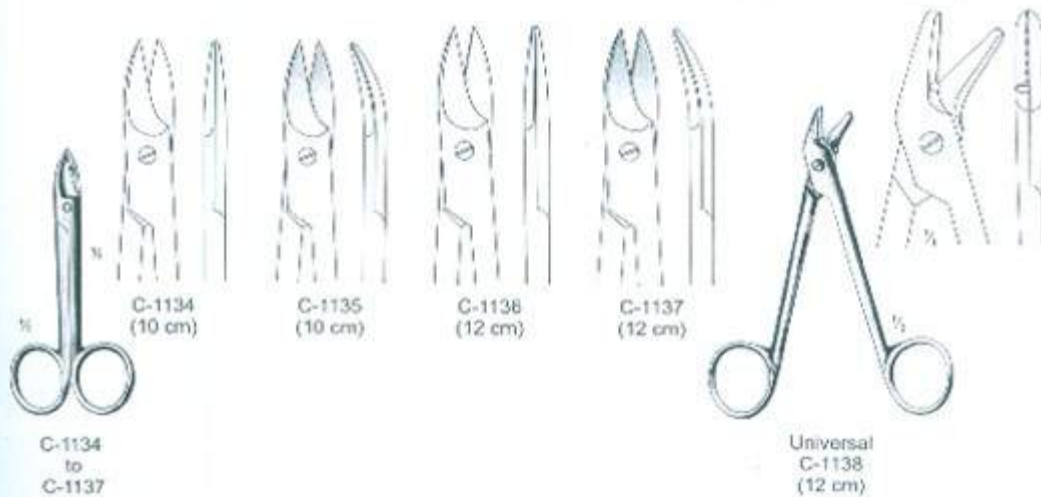
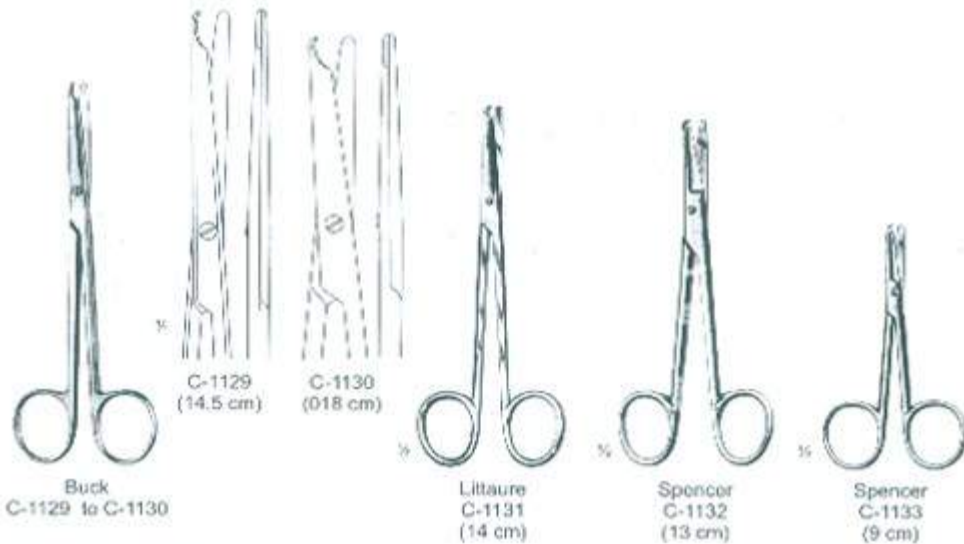



UMBILICAL
SCISSORS

Surgical
Instrumen

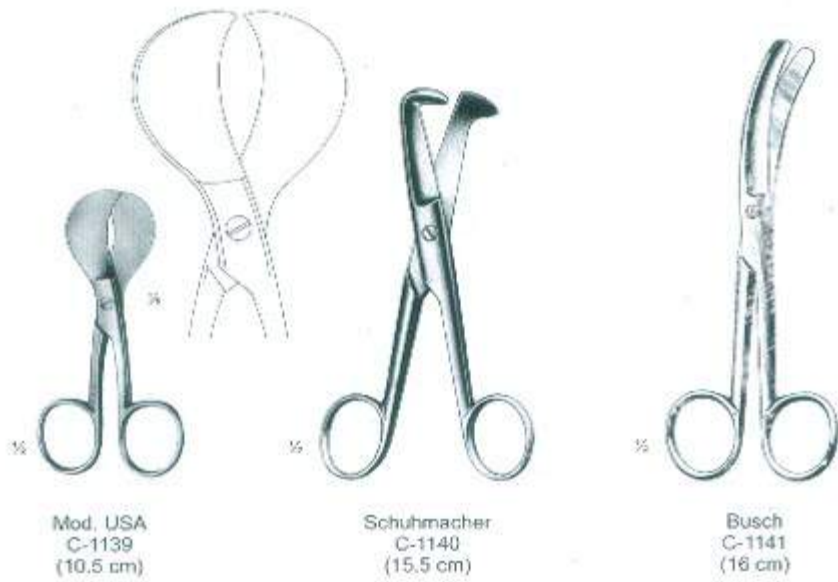

DRESSING FORCEPS

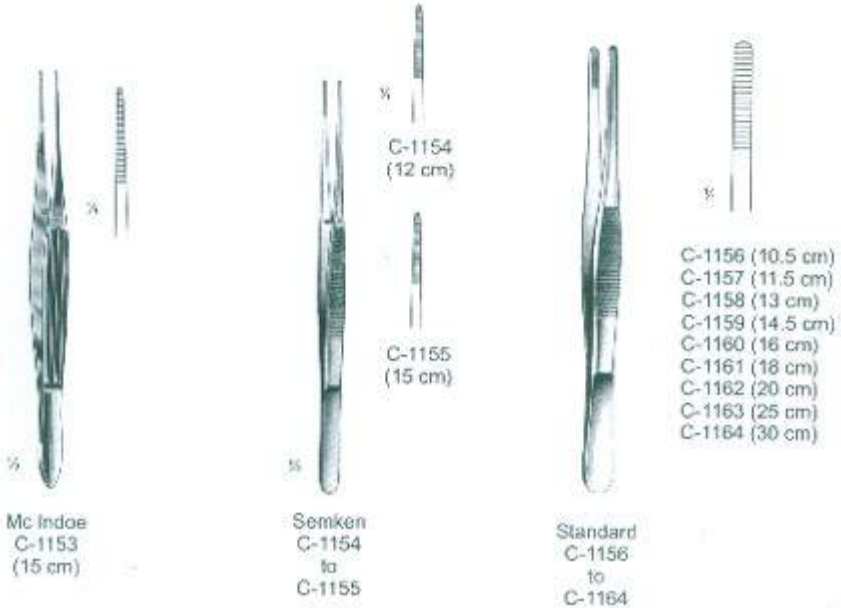
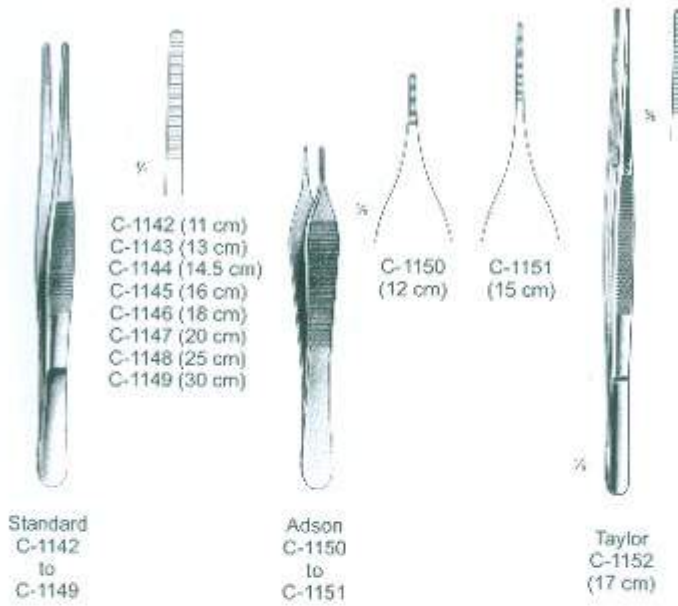



TISSUE FORCEPS

Surgical Instruments

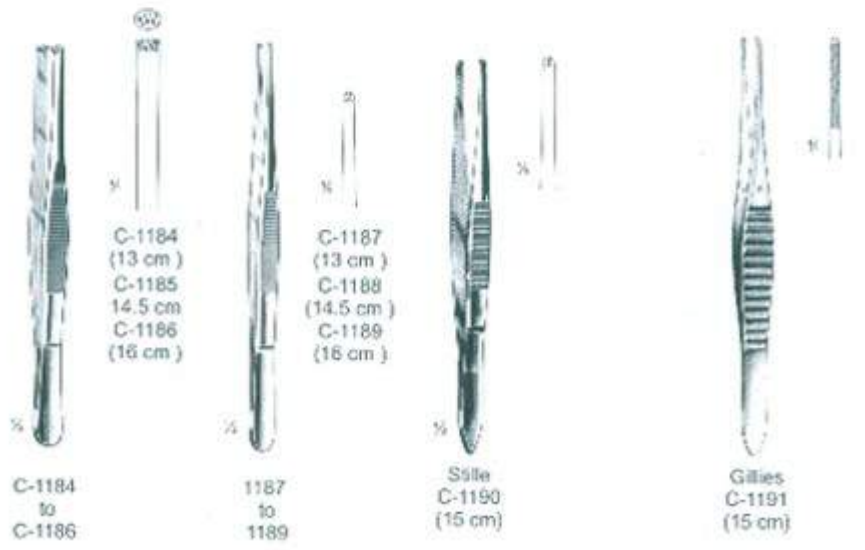
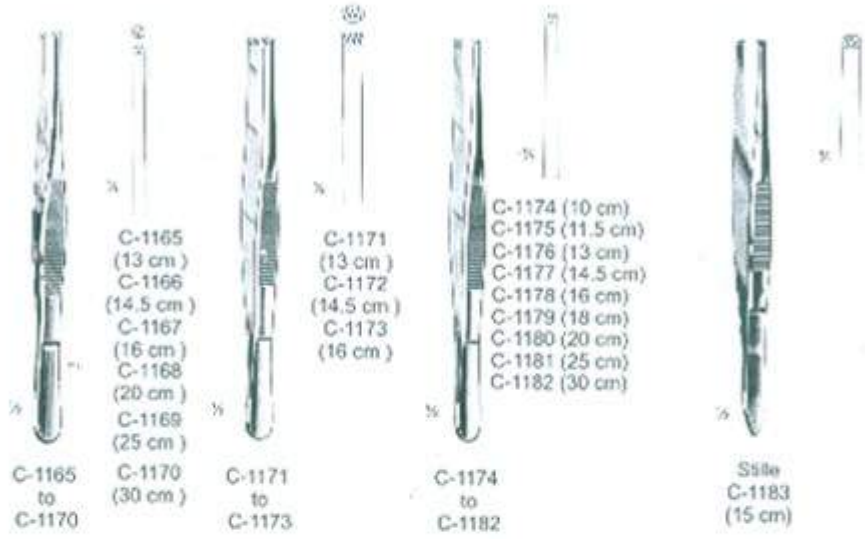

ARTERY FORCEPS



Halsted-Mosquito
C-1192
to
C-1199



C-1192 (16 cm) C-1194 (16 cm)
C-1193 (18 cm) C-1195 (18 cm)



C-1196 (16 cm) C-1198 (16 cm)
C-1197 (18 cm) C-1199 (18 cm)



Mosquito
C-1200
to
C-1207



C-1200 (10.5 cm) C-1202 (10.5 cm)
C-1201 (12.5 cm) C-1203 (12.5 cm)



C-1204 (10.5 cm) C-1206 (10.5 cm)
C-1205 (12.5 cm) C-1207 (12.5 cm)



Crile
C-1208 to C-1211
(16 cm)



C-1208 C-1209 C-1210 C-1211

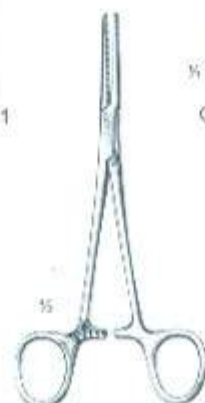

Crile
C-1212 to C-1215
(14 cm)



C-1212 C-1213



C-1214 C-1215



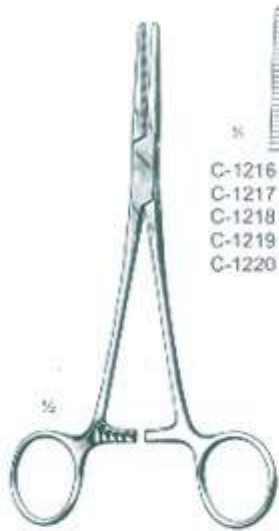

ARTERY FORCEPS

Surgical Instrument:



Spencer-Wells
C-1216
to
C-1225

- | | |
|---|---|
|  X |  X |
| C-1216 (13 cm) | C-1221 (13 cm) |
| C-1217 (14 cm) | C-1222 (14 cm) |
| C-1218 (15 cm) | C-1223 (15 cm) |
| C-1219 (18 cm) | C-1224 (18 cm) |
| C-1220 (20 cm) | C-1225 (20 cm) |



Kelly
C-1226
to
C-1227
(14 cm)

- | | |
|---|---|
|  X |  X |
| C-1226 | C-1227 |



Hartmann
C-1228 to C-1229
(10 cm)

- | | |
|---|---|
|  X |  X |
| C-1228 | C-1229 |

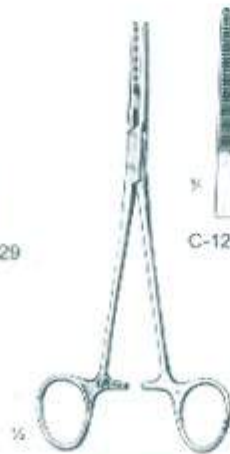

Kelly-Rankin
C-1230 to C-1231
(18 cm)

- | | |
|---|---|
|  X |  X |
| C-1230 | C-1231 |



Baby-Mixer
C-1232 to C-1233
(14 cm)

- | | |
|---|---|
|  X |  X |
| C-1232 | C-1233 |

ARTERY FORCEPS

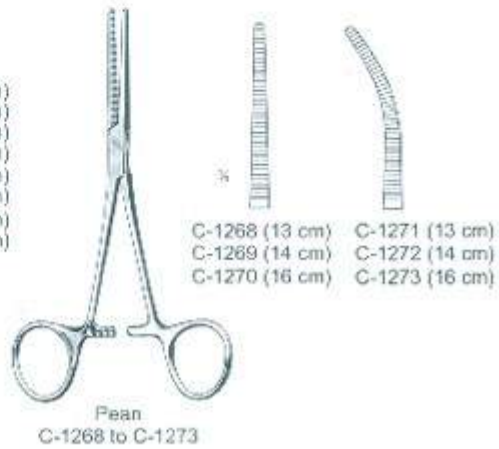
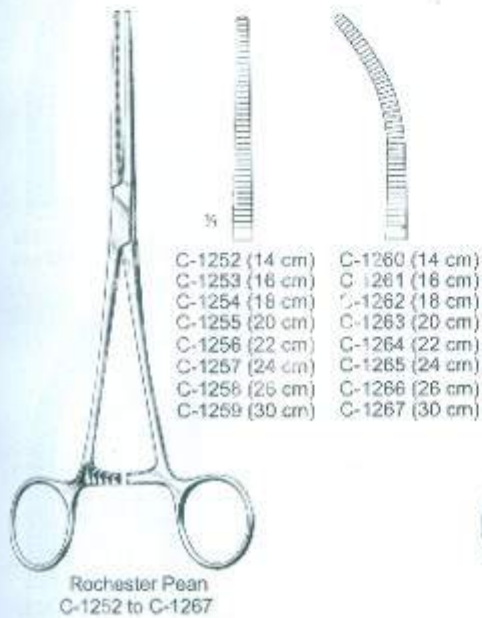
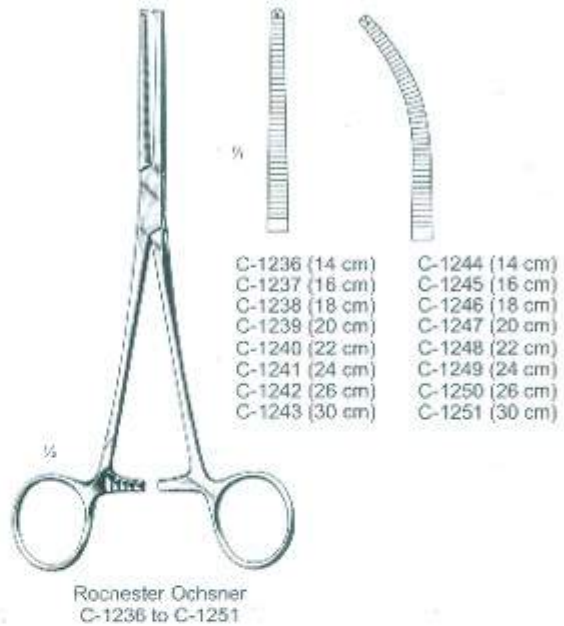
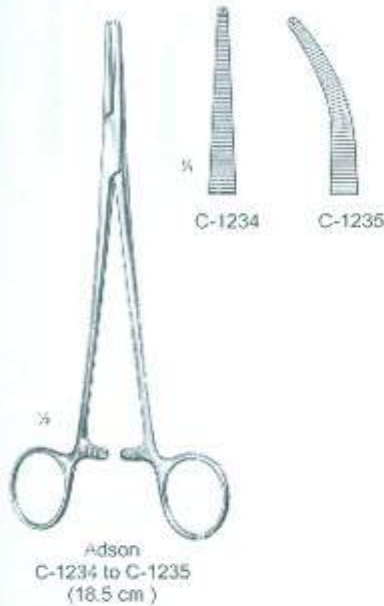



ARTERY AND HYSTERECTOMY
FORCEPS

Surgical
Instruments

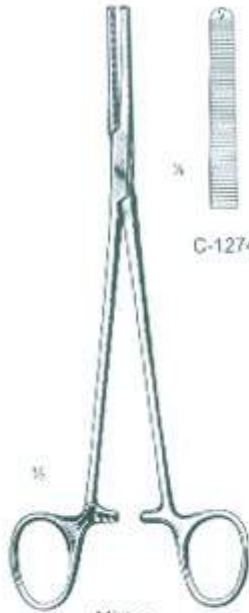

Mixer
C-1274 to C-1275
(21.5 cm)



C-1274



C-1275



Mixer
C-1276 to C-1277
(19 cm)



C-1276



C-1277



Mixer
C-1278 to C-1279



C-1278
(21 cm)



C-1279
(21 cm)



Honey
C-1280 to C-1285



C-1280
(19 cm)



C-1281
(21 cm)



C-1282
(30 cm)



C-1283
(19 cm)



C-1284
(21 cm)



C-1285
(30 cm)



TOWEL FORCEPS

Surgical Instruments



C-1286 (11 cm)
C-1287 (13 cm)



C-1288
(11 cm)



Tohoku
C-1289 (10 cm)
C-1290 (13 cm)



Backhaus
C-1291 (8 cm)
C-1292 (11 cm)
C-1293 (13 cm)
C-1294 (15 cm)



Roeder
C-1295 (13 cm)
C-1296 (15 cm)



Tohoku
C-1297 (5 cm)
C-1298 (9 cm)



Schaedel
C-1299
(9 cm)



POLYPUS AND
SPONGE HOLDING FORCEPS

Surgical
Instruments



Bozemann-Douglas
C-1300
(26 cm)



Foerster
C-1301 to C-1302
(25 cm)



C-1301



C-1302



Rampley
C-1303
(26 cm)



SPONGE HOLDING
FORCEPS

Surgical
Instruments

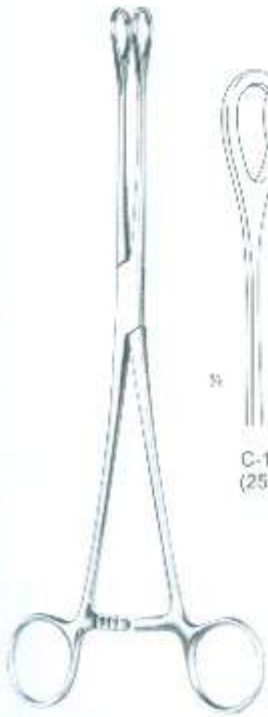

Foerster
C-1304 to C-1311



C-1304
(25 cm)



C-1305 (18 cm)
C-1306 (20 cm)
C-1307 (25 cm)



C-1308
(25 cm)

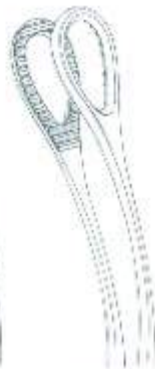

C-1309 (18 cm)
C-1310 (20 cm)
C-1311 (25 cm)



RETRACTOR

Surgical
Instruments

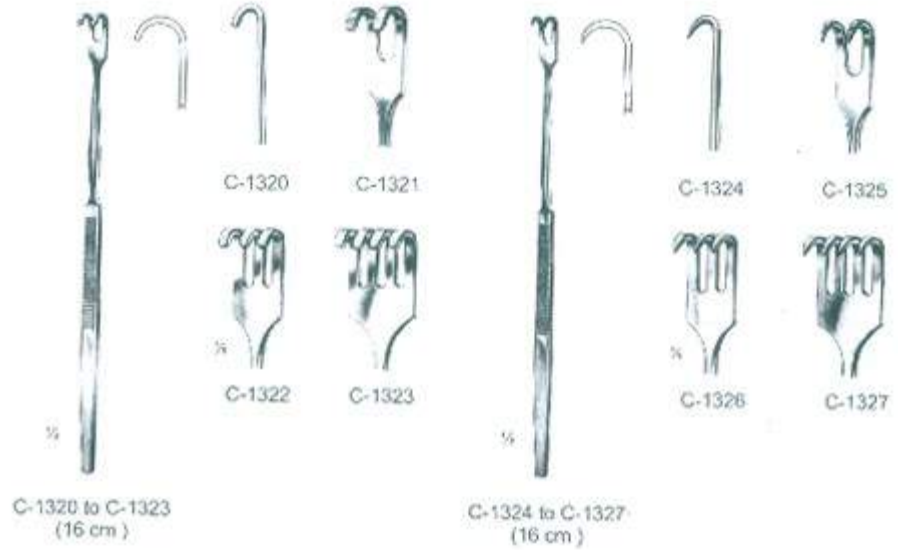
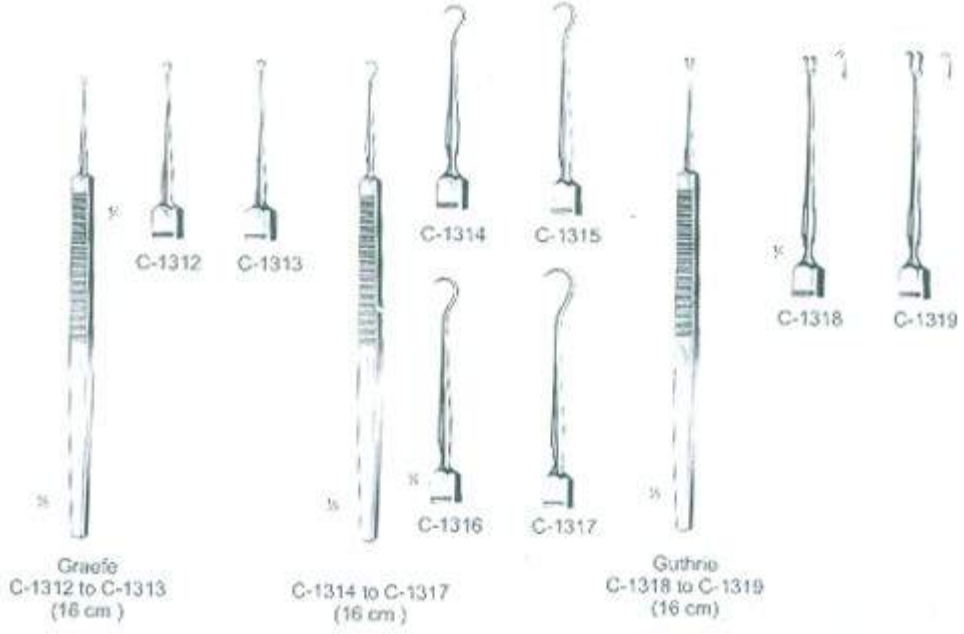

RETRACTOR

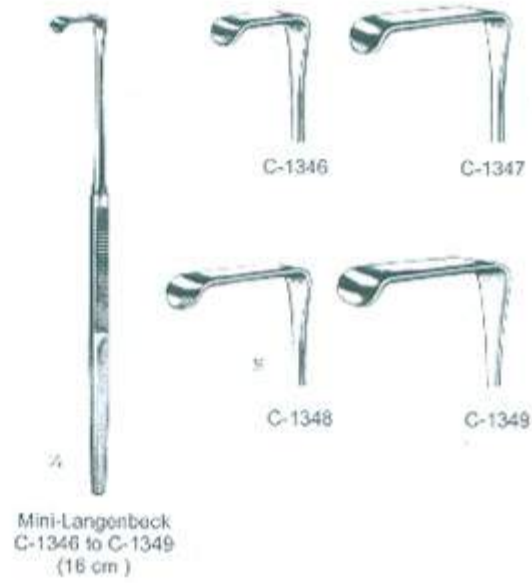
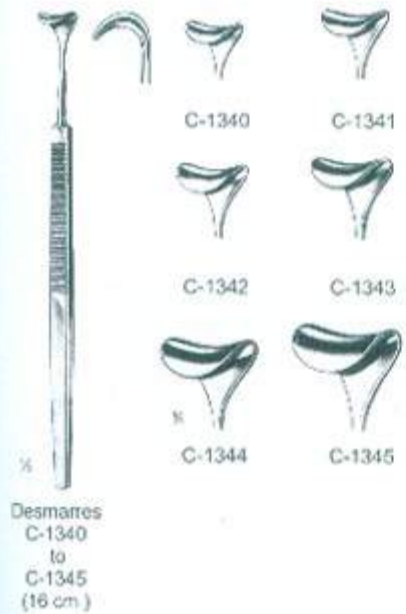
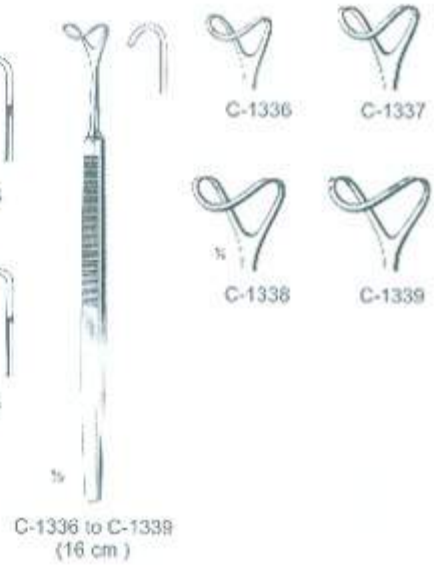
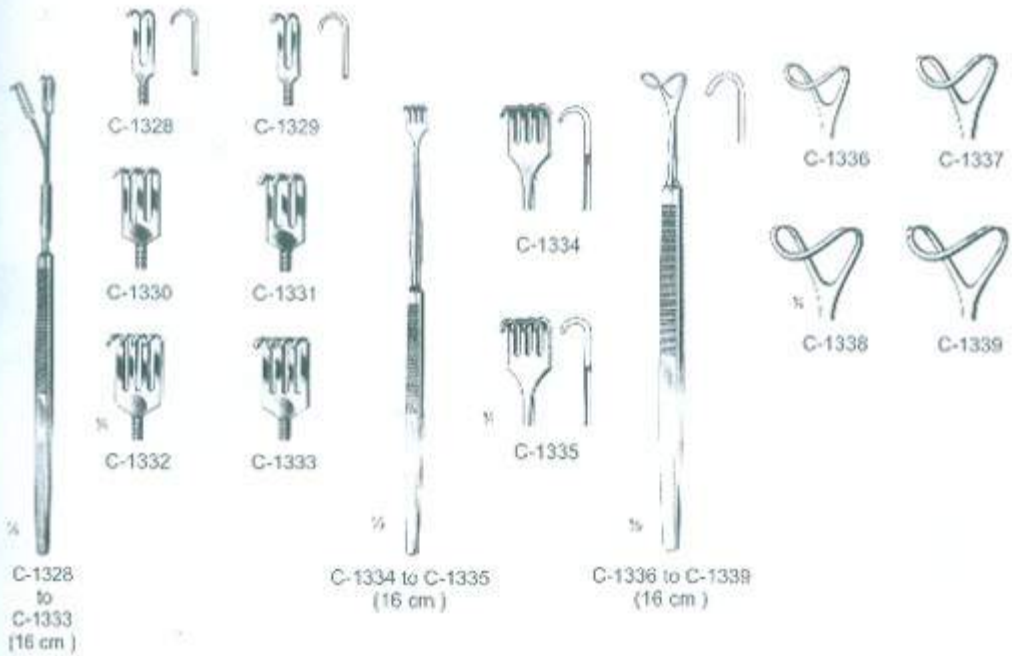



RETRACTOR

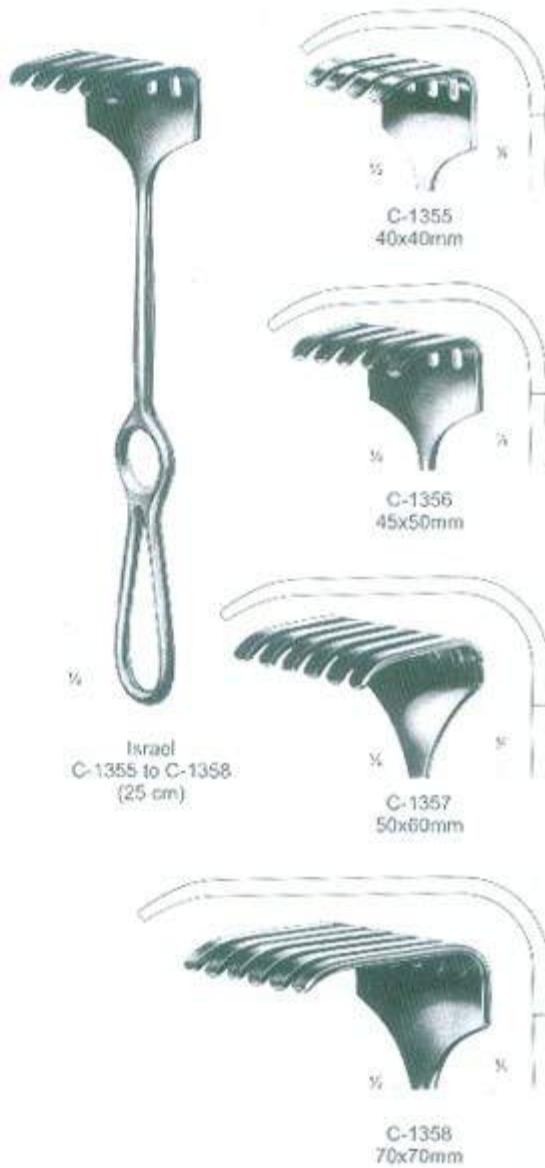
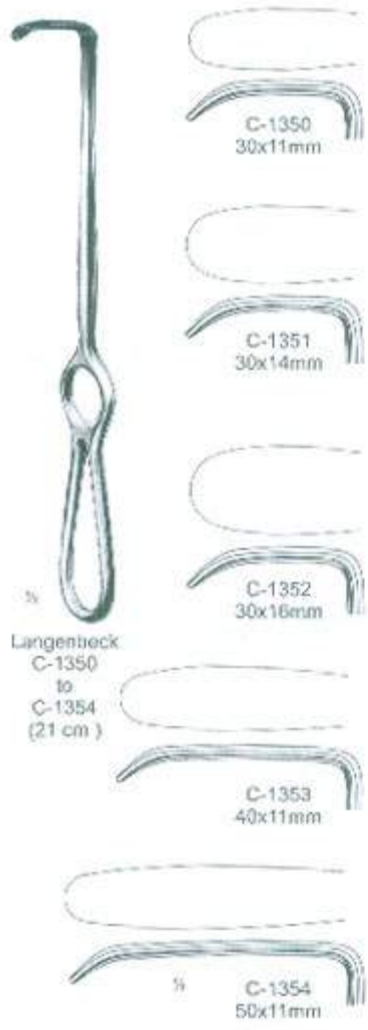

RETRACTOR

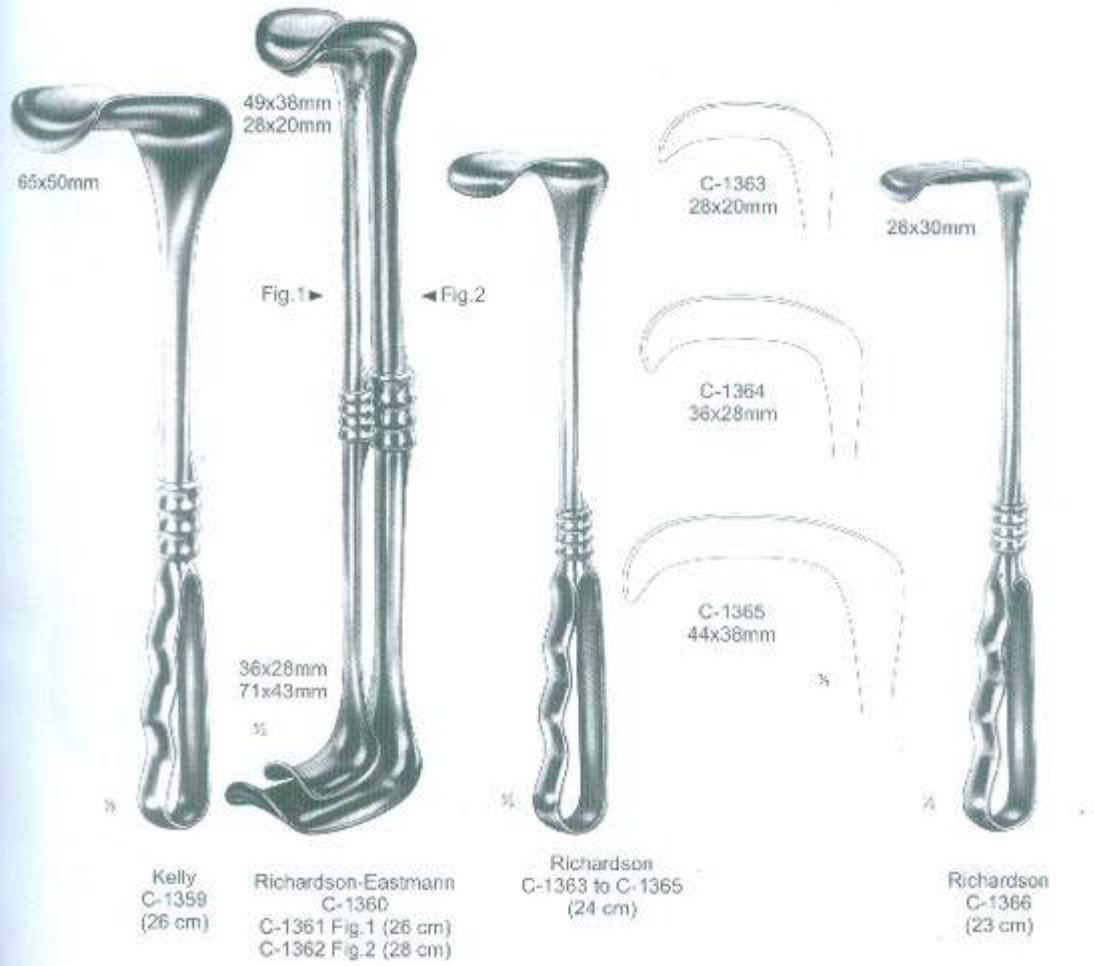



RETRACTOR

Surgical Instruments



RETRACTOR





RETRACTOR

Surgical Instruments



Mollison
C-1378
(15 cm)



Weitlaner-Wulstein
C-1379 to C-1380
(13 cm)

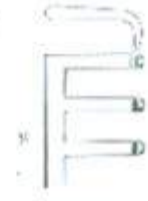

C-1379



C-1380



Adson
C-1381 to C-1384
(26.5 cm)



C-1381



C-1382

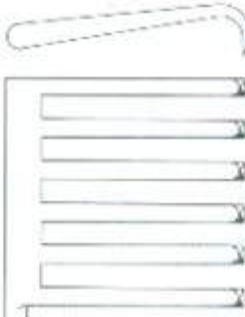

C-1383

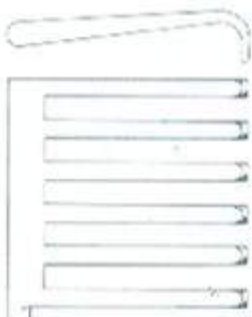

C-1384



RETRACTOR

Surgical
Instruments

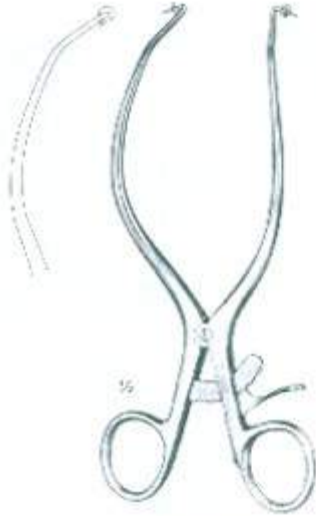

Gelpi-Loktite
C-1385
(18 cm)

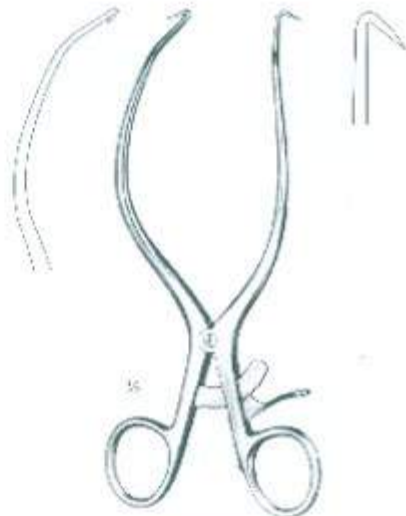

Gelpi-Loktite
C-1386
(18 cm)

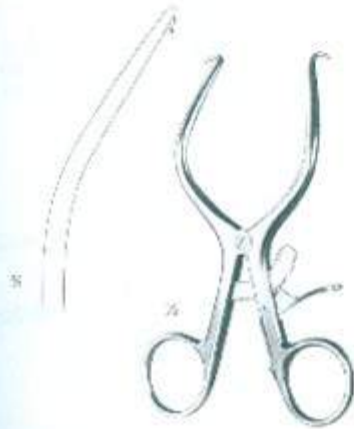

Gelpi-Loktite
C-1387
(13 cm)

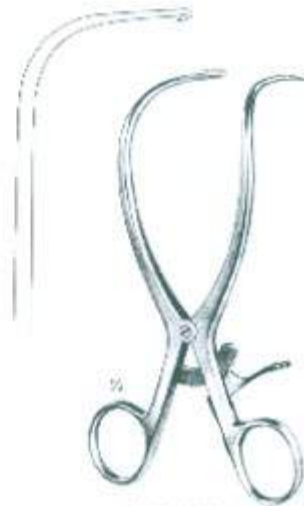

Gelpi-Seiletz
C-1388
(15 cm)



ABDOMINAL RETRACTOR

Surgical
Instruments



Collin-Lokthe
C-1389
(26 cm)

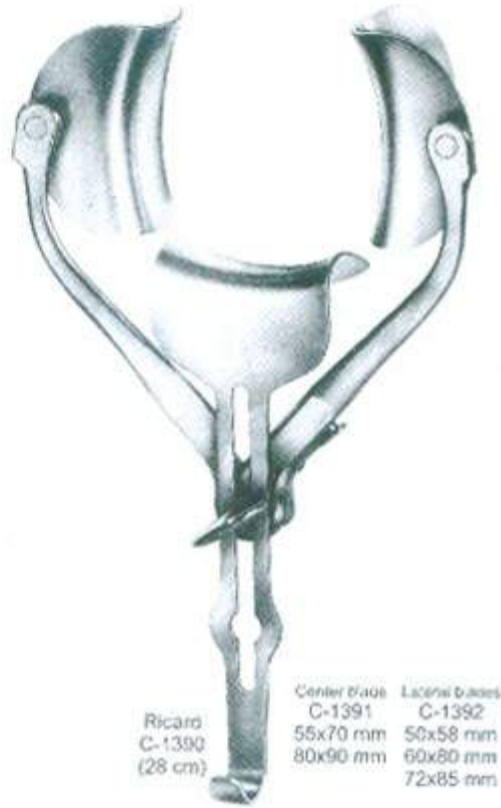

Ricard
C-1390
(28 cm)

Center blade	Lateral blades
C-1391 55x70 mm	C-1392 50x58 mm
80x90 mm	60x80 mm
	72x85 mm

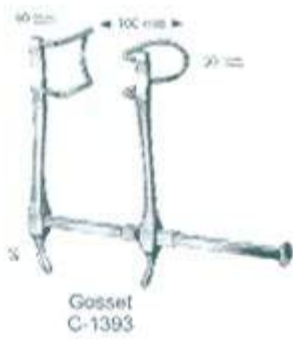

Gossel
C-1393

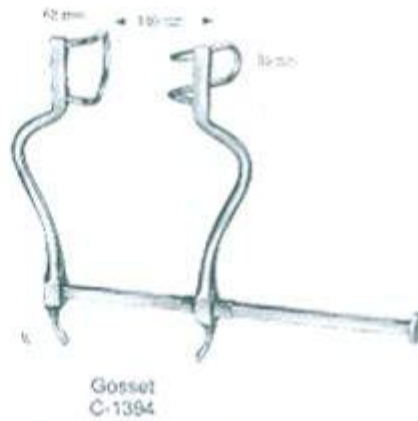

Gossel
C-1394

ABDOMINAL RETRACTOR

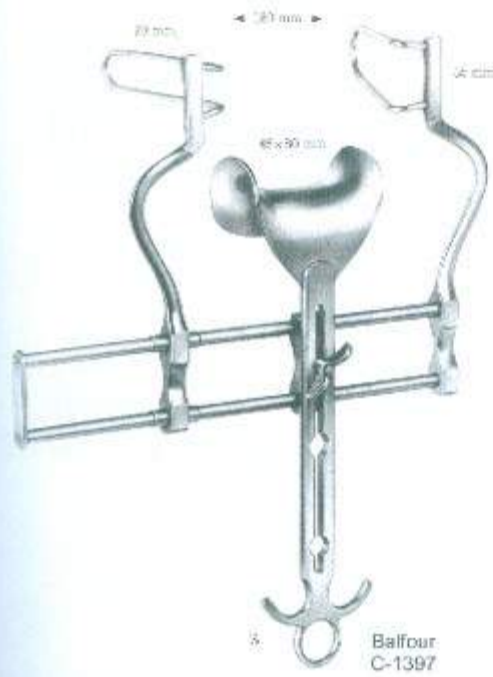



TROCARS, SUCTION TUBES

Surgical Instruments

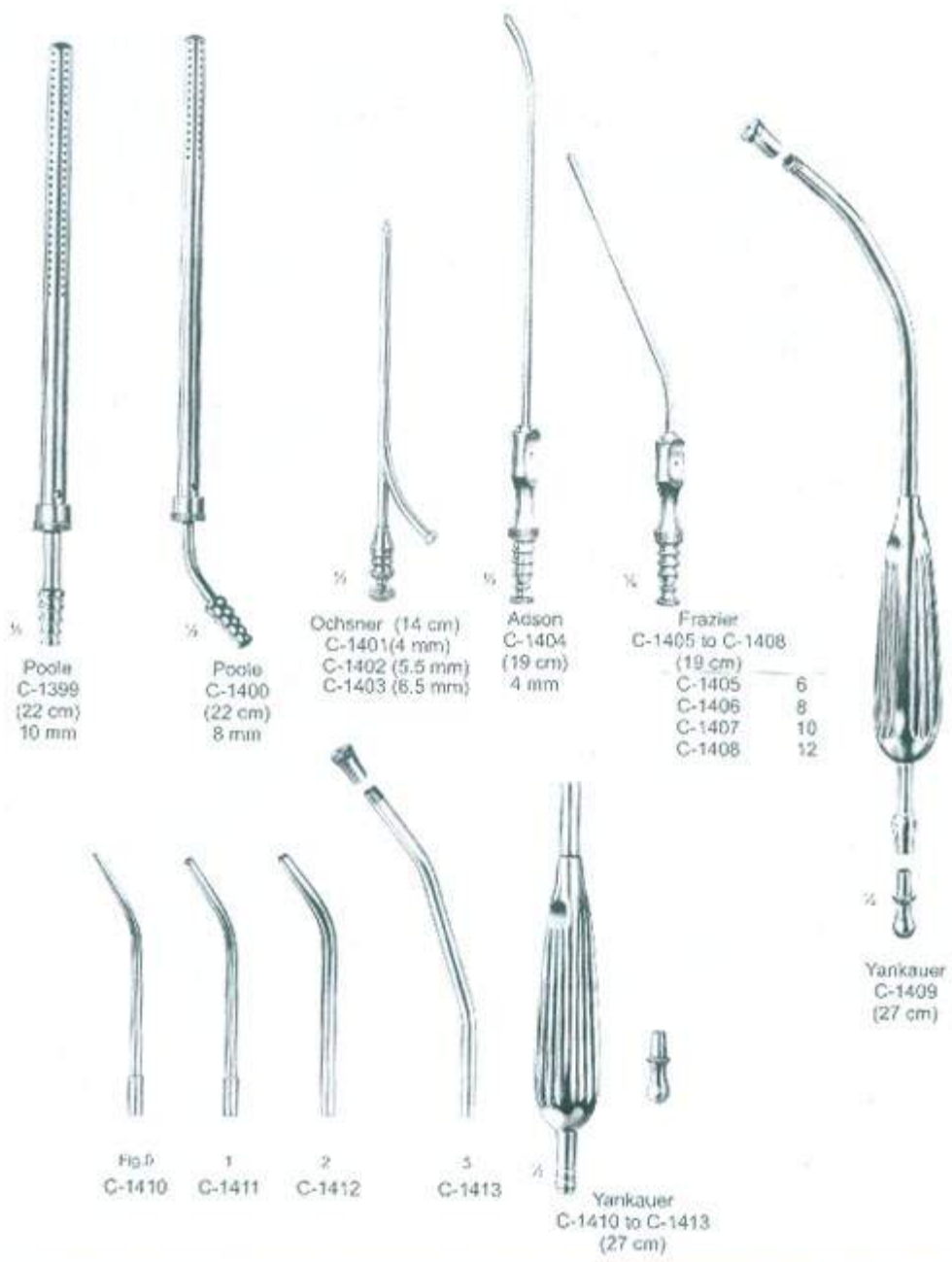

CATHETER FORCEPS, LARYNGOSCOPE

Surgical
Instruments





MICRO, NEEDLE HOLDERS

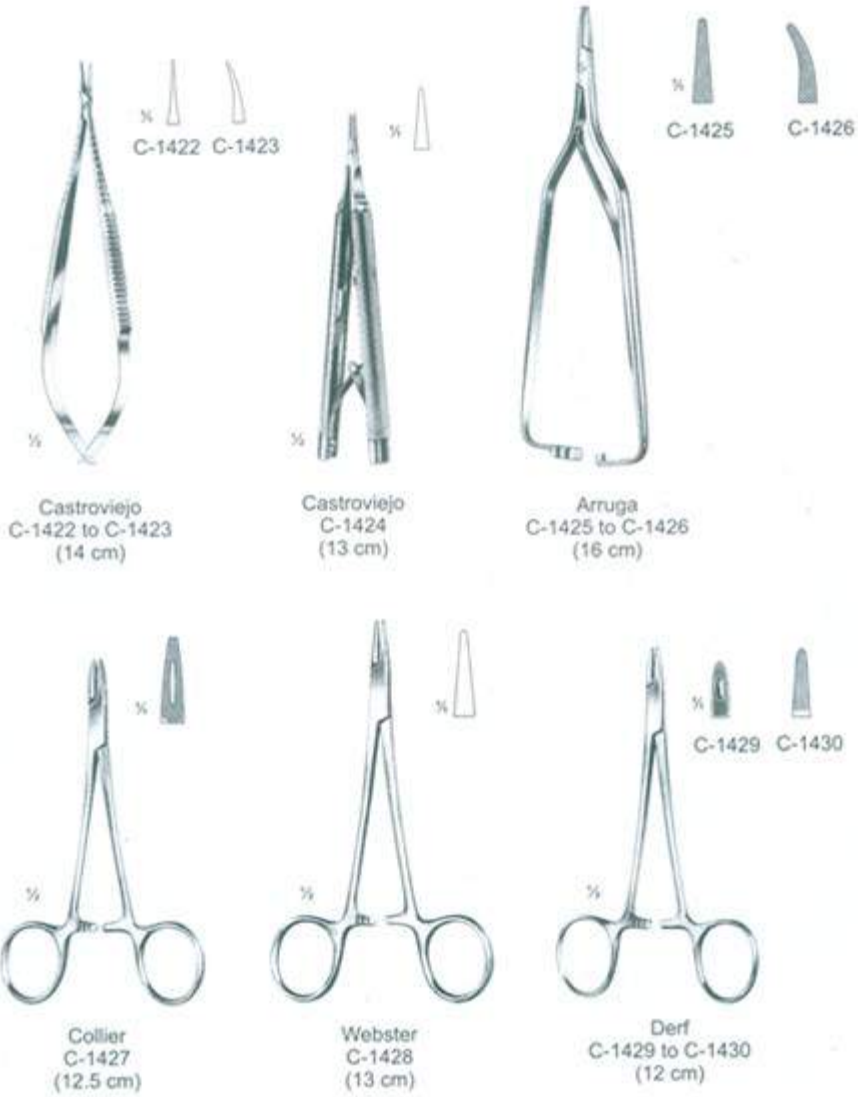

NEEDLE HOLDERS



Halsey
C-1431
(13 cm)



Neivert
C-1432
(13 cm)



Hegar-Baumgartner
C-1433
(14 cm)



Brown
C-1434 (13 cm)
C-1435 (18 cm)



Crile-Murray
C-1436
(15 cm)



Crile-Murray
C-1437
(15 cm)



Adson
C-1438
(18 cm)



Metzenbaum
C-1439
(18 cm)



NEEDLE HOLDERS

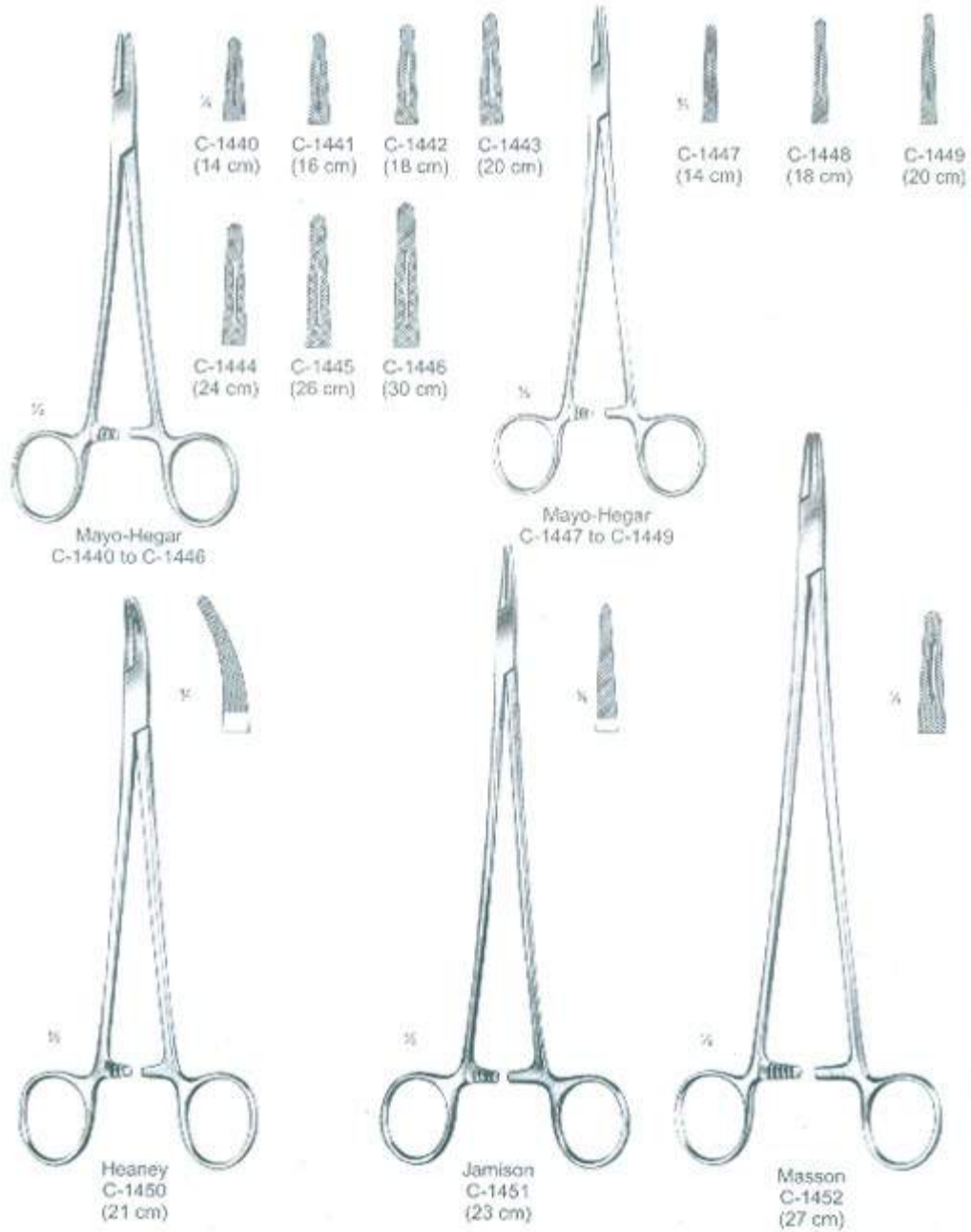

Mayo-Hegar
C-1440 to C-1446

Mayo-Hegar
C-1447 to C-1449

Heaney
C-1450
(21 cm)

Jamison
C-1451
(23 cm)

Masson
C-1452
(27 cm)

NEEDLE HOLDERS



Olsen-Hegar
C-1453 to C-1455



C-1453
(14 cm)



C-1454
(17 cm)



C-1455
(18 cm)

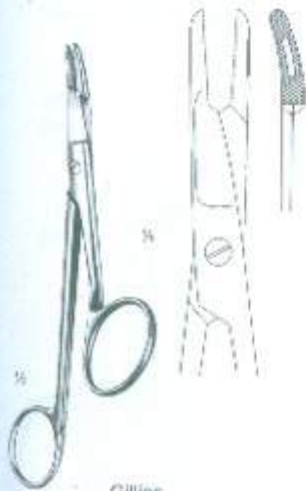

Gillies
C-1456
(16 cm)



Crile
C-1457
(15 cm)



Stratte
C-1458
(23 cm)

MICRO, NEEDLE HOLDERS

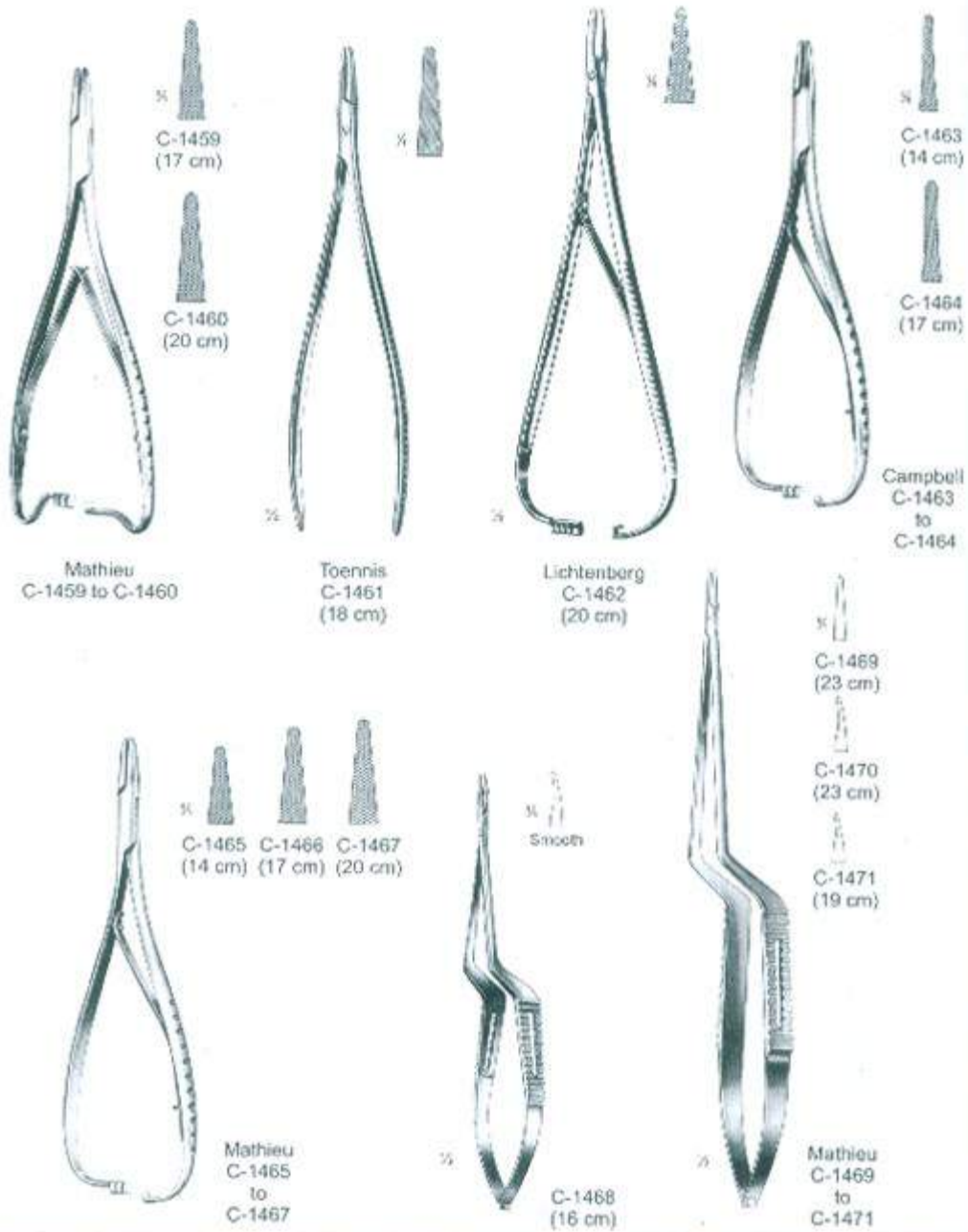

BANDAGE AND CLOTHING SCISSORS
PLASTER SHEARS



Lister
C-1472 (9 cm)
C-1473 (14 cm)
C-1474 (18 cm)
C-1475 (20 cm)



C-1476
(20 cm)

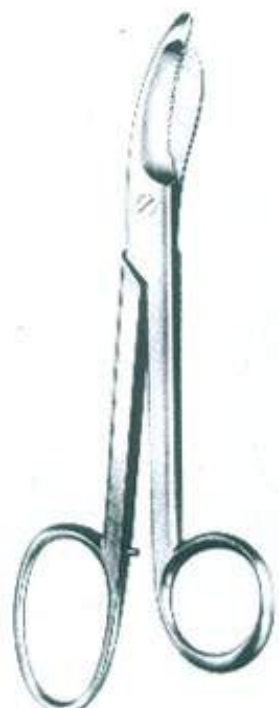

Bruns
C-1477
(24 cm)



Utility
C-1478 (15 cm)
C-1479 (18 cm)



Stille
C-1480 (20 cm)
C-1481 (22 cm)



PLASTER KNIVES, SAWS
PLASTER CAST INSTRUMENTS



Hopkins
C-1482
(20 cm)



Esmarch
C-1483
(18 cm)



Reiner
C-1484
(18 cm)



Engel
C-1485
(14 cm)



Wolff
C-1486 to C-1487



C-1486
(18 cm)



C-1487
(24 cm)



Hennig
C-1488
(28 cm)

AMPUTATING AND RESECTION SAWS
BONE HOLDING CLAMPS



Gerster-lowmann
C-1489 to C-1488



C-1489
(18 cm)



C-1490
(20 cm)



C-1491
(22 cm)



Spare saws
Blades
C-1492 (12 mm)
C-1493 (15 mm)



Chriero
C-1494
(35 cm)



Chriero
C-1495 (27 cm)
C-1496 (30 cm)



Satterios
C-1497
(31 cm)



BONE WIRE TIGHTENERS EXTENSION BOWS

Surgical
Instruments



Demol
C-1498
(28 cm)



Loute
C-1499
(21 cm)

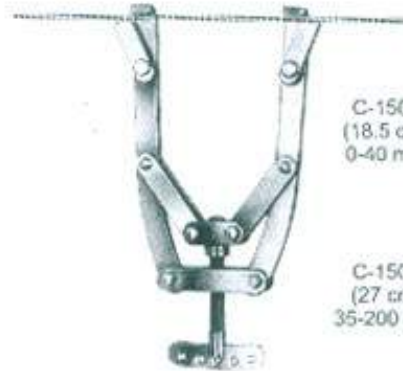

C-1500
(18.5 cm)
0-40 mm

C-1501
(27 cm)
35-200 mm

Kirschner
C-1500 to C-1501

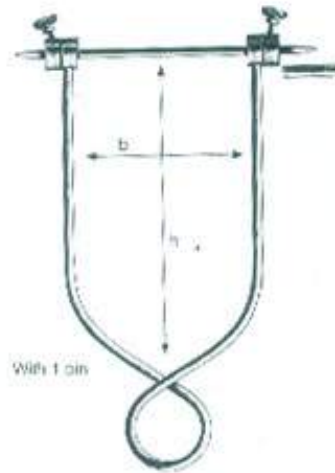

With 1 cm

Böhrer

For Arm	For thigh and knee	For femur and knee
C-1502	C-1503	C-1504
6 1/4 x 3 1/2	8 1/4 x 4 1/2	8" x 6"
18 x 9	21 x 11	21 x 15

GOUGES, MALLETS AND
PERIOSTEAL ELEVATORS

With interchangeable
ferrozell hammers
26 mm

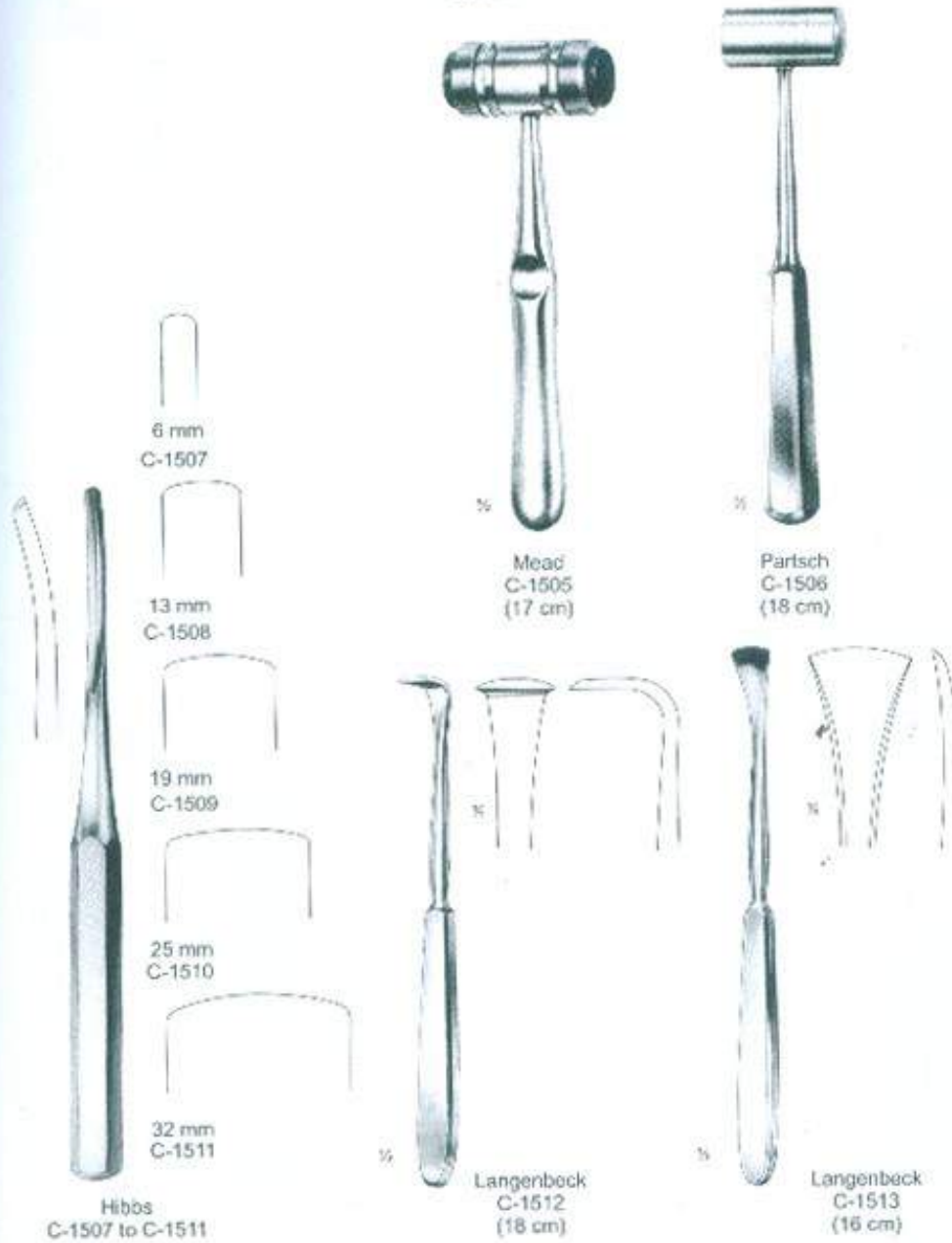

PERIOSTEAL RASPATORIES

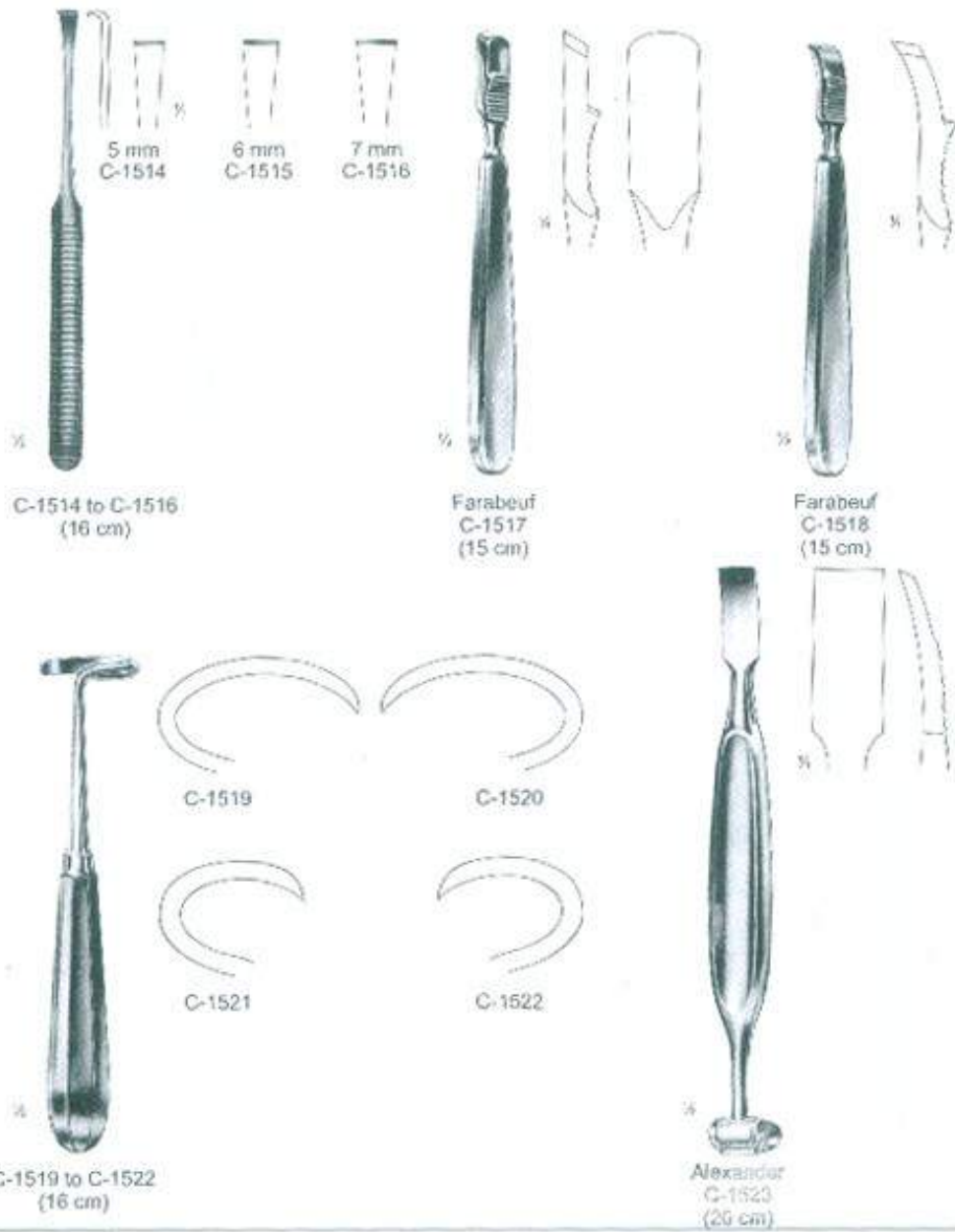

BONE LEVERS



Bennett
C-1524
(24 cm)



Blount
C-1525
(26 cm)



Blount
C-1526
(26 cm)



Hohmann
C-1527
8 mm



Hohmann
C-1528
18 mm



Hohmann
C-1529
43 mm



Hohmann
C-1530
70 mm

BONE HOLDING FORCEPS



Lane
C-1537 to C-1540



C-1537 (45 cm)
Without ratchet
C-1538 (45 cm)
With ratchet



C-1539 (33 cm)
Without Ratchet
C-1540 (33 cm)
With Ratchet



C-1541 (15 cm)
C-1542 (19 cm)
C-1543 (24 cm)
C-1544 (26 cm)
C-1545 (28 cm)



C-1541 to C-1545



BONE HOLDING FORCEPS

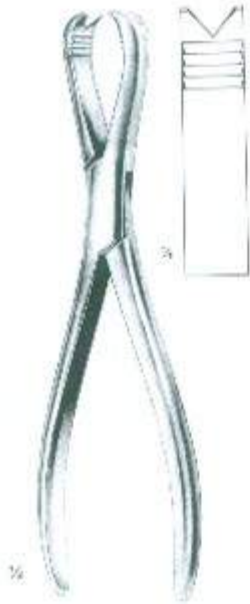

Langenbeck
C-1531
(21 cm)

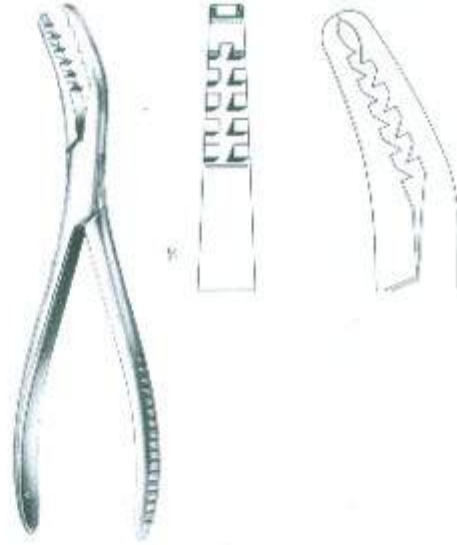

Semb
C-1532
(19 cm)



Kern
C-1533
to
C-1534

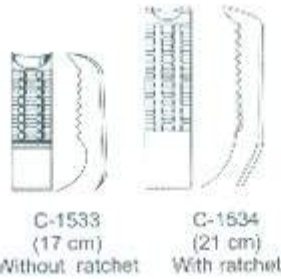

C-1533
(17 cm)
Without ratchet

C-1534
(21 cm)
With ratchet



Kern
C-1535
to
C-1536

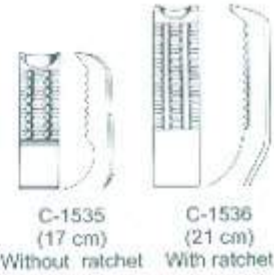

C-1535
(17 cm)
Without ratchet

C-1536
(21 cm)
With ratchet



BONE RONGEUR FORCEPS



Surgical Instruments

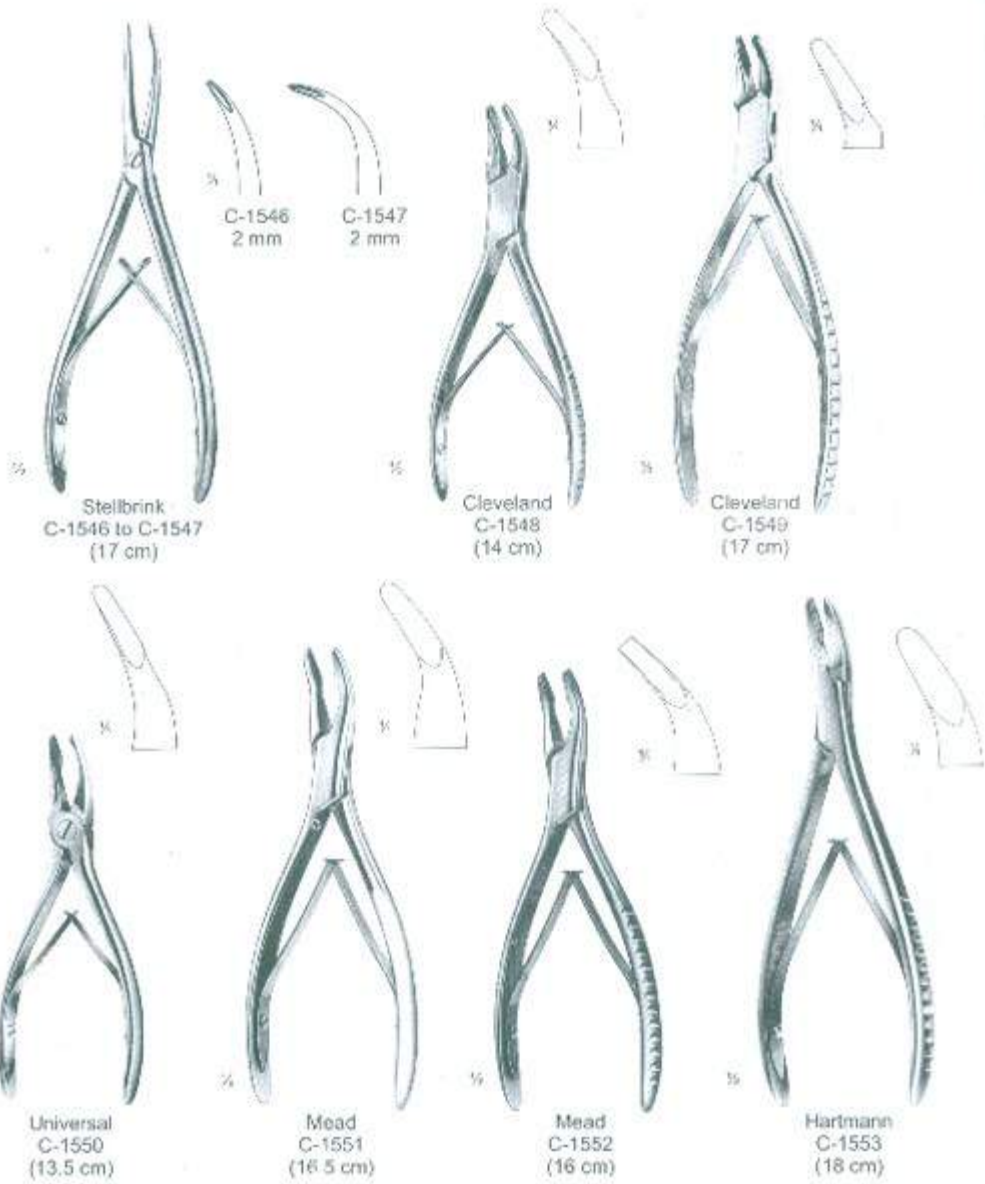

BONE RONGEUR FORCEPS

Instruments

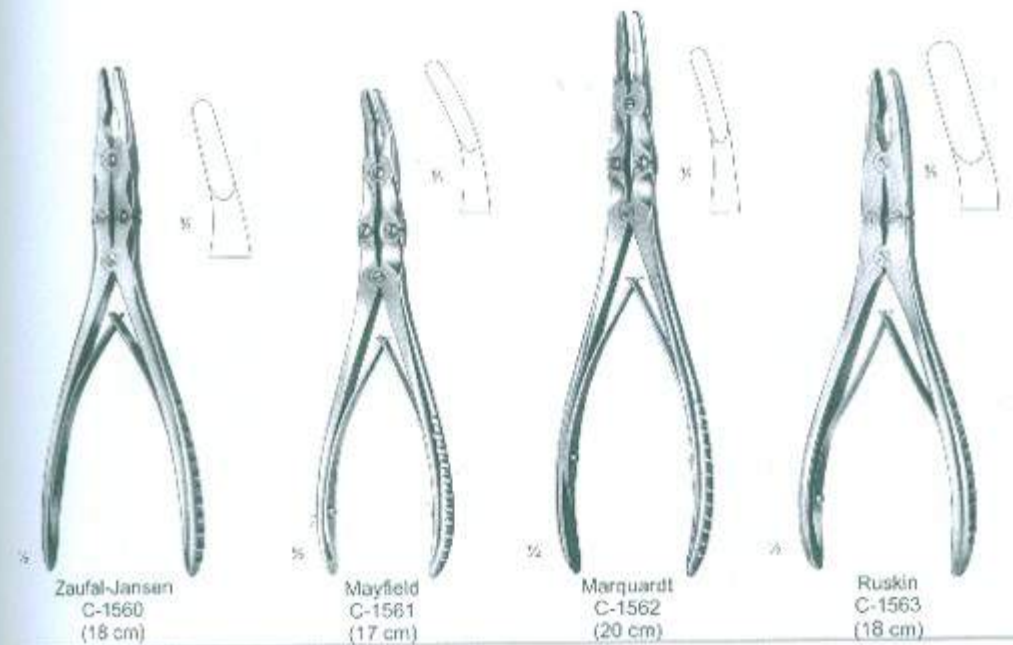
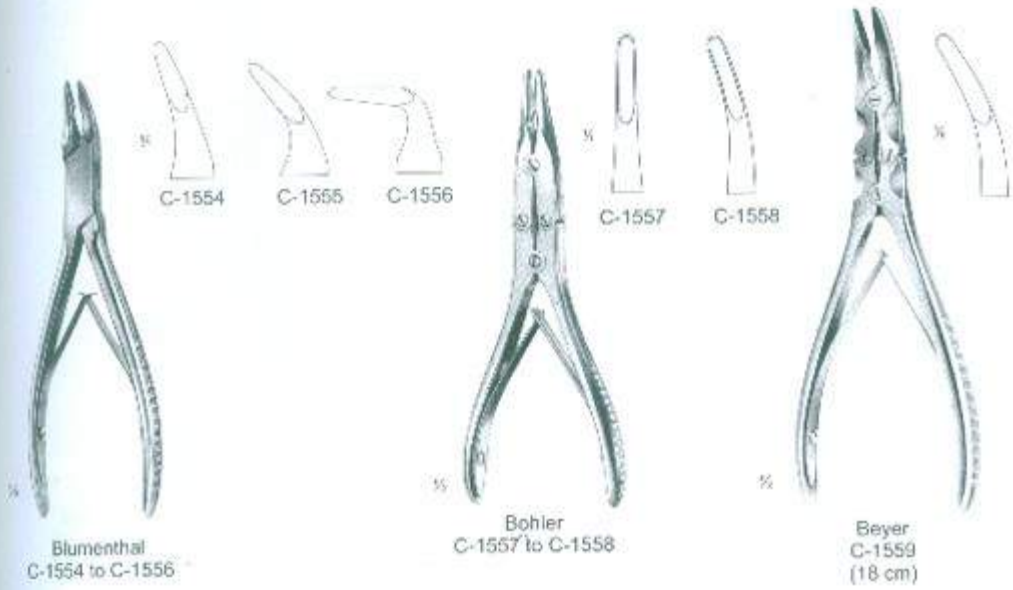



BONE RONGEUR FORCEPS

Surgical
Instruments



Ruskin
C-1564
(23 cm)



Stille
C-1565
(23 cm)

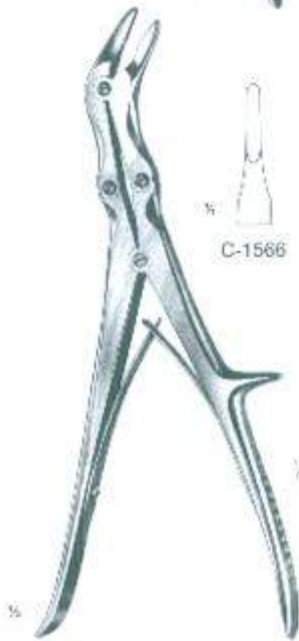

Echlin
C-1566 to C-1568
(23 cm)



C-1566

C-1567

C-1568

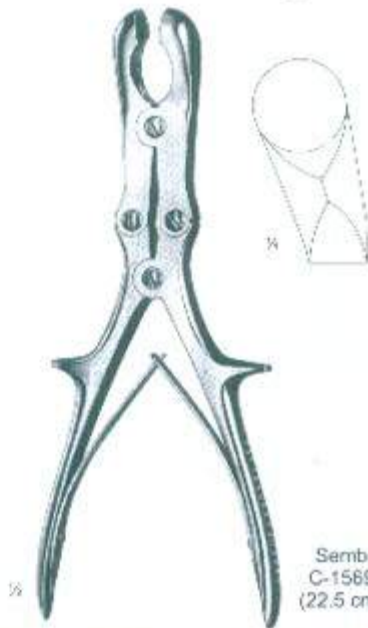

Semb
C-1589
(22.5 cm)

BONE CUTTING FORCEPS



C-1571
(23cm)



C-1572
(27 cm)

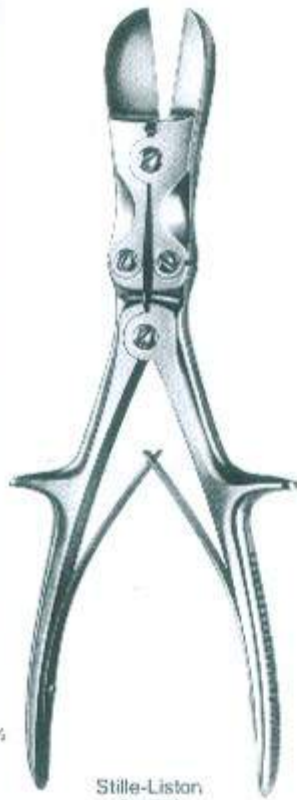

Stille-Liston
C-1570
(27 cm)

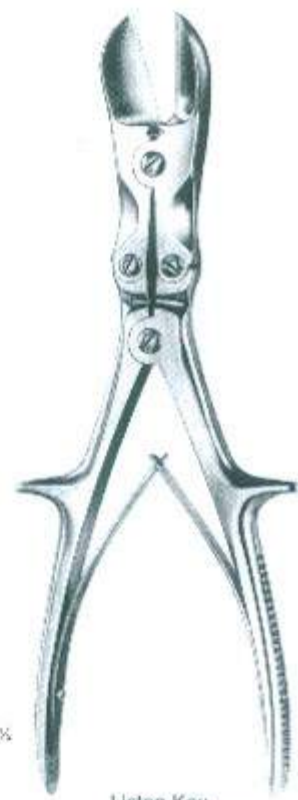

Liston-Key
C-1571 to C-1572



TISSUE AND ORGAN HOLDING
FORCEPS

Surgical
Instruments

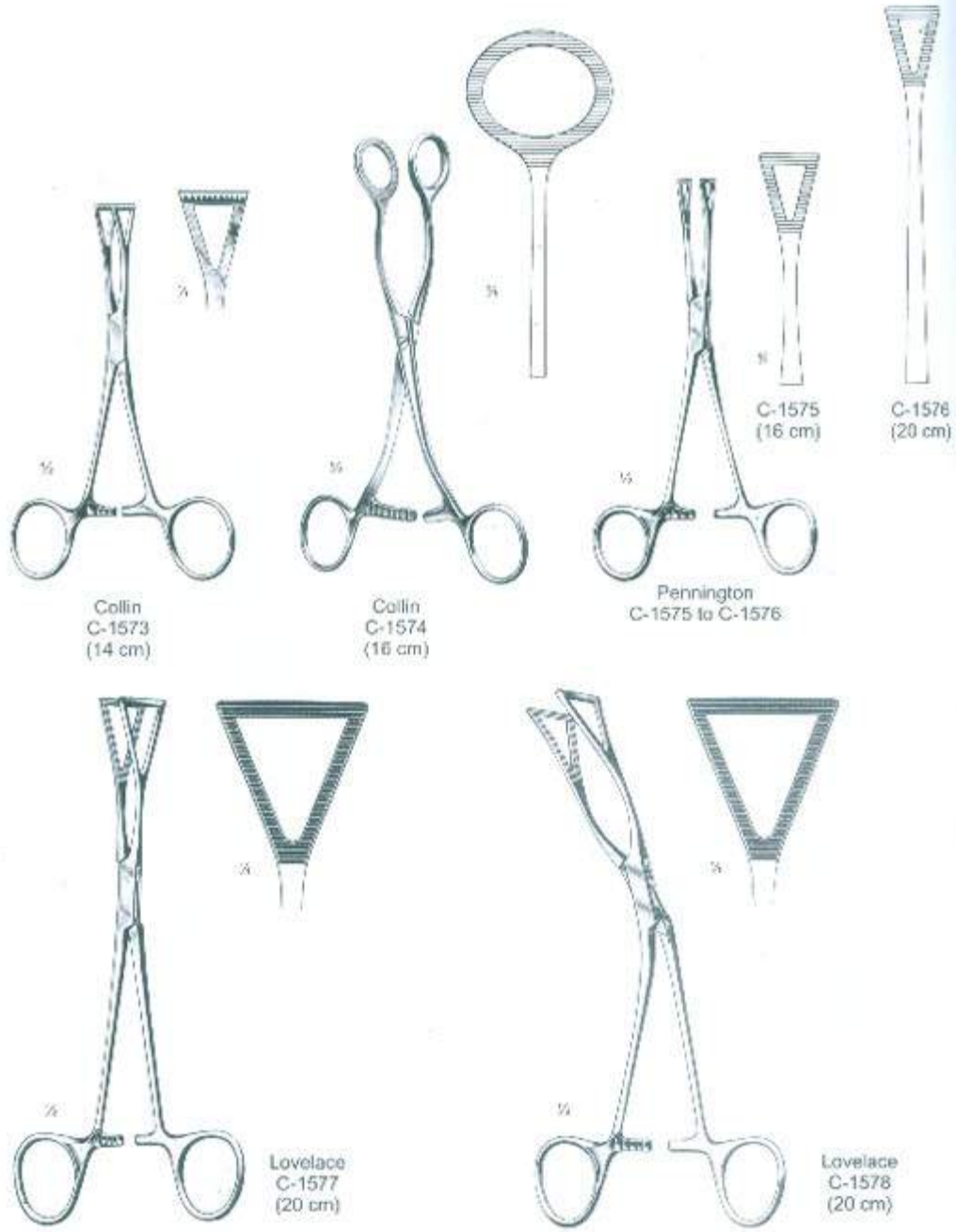



CLIPS APPLYING
FORCEPS



McKenzie
C-1579 (15 cm)
C-1580 (19 cm)



McKenzie
C-1581 (15 cm)
C-1582 (19 cm)

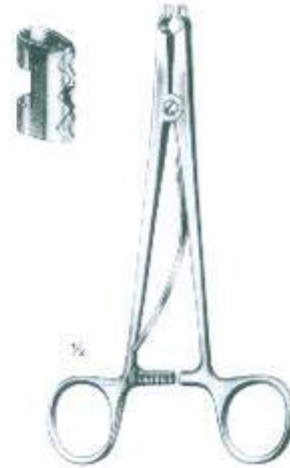

Raney
C-1583



Olivecrona-Toennis
(Scoville)
C-1584

LAMINA SPREADERS

Instruments



Cloward
C-1585
(16 cm)

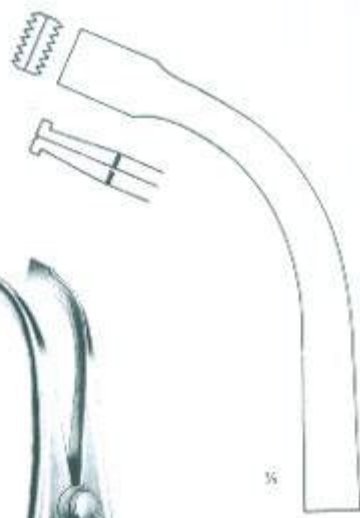

Inge
C-1587
(27 cm)



Inge
C-1586
(17 cm)

TISSUE AND ORGAN
HOLDING FORCEPS



Allis-Baby
C-1588
(12 cm)
4:5 teeth

4:5
X 
C-1589
(15 cm)



Allis
C-1589 to C-1592

5:6
X 
C-1590
(15 cm)
C-1591
(19 cm)
C-1592
(23 cm)



Allis-Adair
C-1593
(15 cm)
10:11 teeth



Boys-Allis
C-1594
(15 cm)



TISSUE AND ORGAN HOLDING FORCEPS

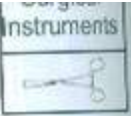

Duval
C-1595 to C-1598

C-1595
(18 cm)
C-1597
(20 cm)

C-1596
(20 cm)
C-1598
(23 cm)



Babcock
C-1599 to C-1602

C-1599
(16 mm)

C-1600
(18 mm)

C-1601
(20 mm)

C-1602
(24 mm)

RECTAL SPECULA, ANAL RETRACTORS
ANOSCOPES, SPHINCTEROSCOPIES, PROCTOSCOPES



Newman
C-1603 (16 mmØx 63 mm)
C-1604 (19 mmØx 63 mm)
C-1605 (23 mmØx 63 mm)



Kelly
C-1606 (21 mmØx 50 mm)
C-1607 (27 mmØx 50 mm)



Kelly
C-1608 (22 mmØx 50 mm)
C-1609 (22 mmØx 100 mm)
C-1610 (22 mmØx 140 mm)



Hirschmann
C-1611 (16 mmØx 65 mm)
C-1612 (19 mmØx 65 mm)
C-1613 (22 mmØx 65 mm)



Barr
C-1614
(17 cm)

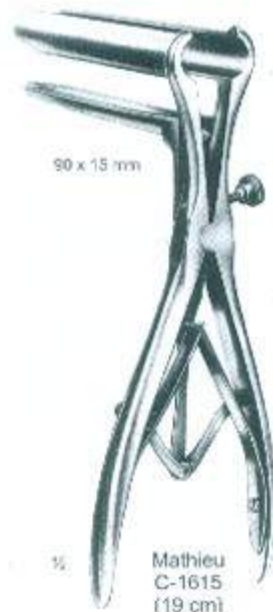

Mathieu
C-1615
(19 cm)

VAGINAL SPECULA



Graves
C-1616 (75x13 mm)
C-1617 (100x22 mm)
C-1618 (120x25 mm)

1/2



Detachable

Collin
C-1619 (85x30 mm)
C-1620 (100x35 mm)
C-1621 (110x40 mm)
C-1622 (100x35 mm)



Cusco
C-1623
S.M.L
Japan pat.

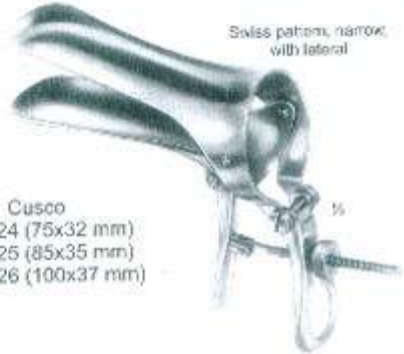

Swiss pattern, narrow, with lateral

Cusco
C-1624 (75x32 mm)
C-1625 (85x35 mm)
C-1626 (100x37 mm)

1/2



Sakuras
C-1627
S.M.L

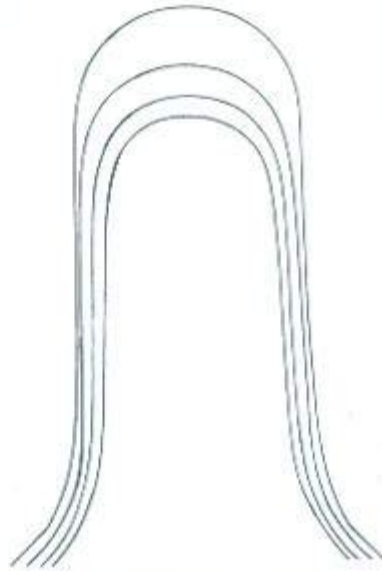

VAGINAL SPECULA



Simm
C-1628 (100x17/20 mm)
C-1629 (100x25/30 mm)

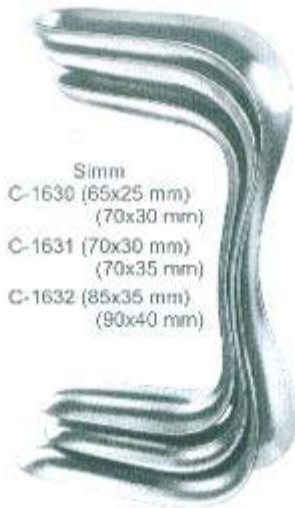

Simm
C-1630 (65x25 mm)
(70x30 mm)
C-1631 (70x30 mm)
(70x35 mm)
C-1632 (85x35 mm)
(90x40 mm)

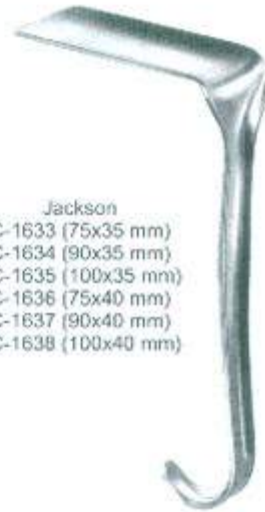

Jackson
C-1633 (75x35 mm)
C-1634 (90x35 mm)
C-1635 (100x35 mm)
C-1636 (75x40 mm)
C-1637 (90x40 mm)
C-1638 (100x40 mm)



Kristeller
Fig.1 C-1639
Fig.2 C-1640
Fig.3 C-1641



Kristeller
Fig.1 C-1642 (75x23 mm)
Fig.2 C-1643 (65x26 mm)
Fig.3 C-1644 (100x32 mm)



Kristeller
Fig.1 C-1645 (70x27 mm)
Fig.2 C-1646 (80x30 mm)
Fig.3 C-1647 (90x36 mm)

UTERINE DILATORS



Utering Dilate Set of 15p



C-1648

Utering Dilate Set of 5p



C-1649

Hegar
C-1650
Set of 8 dilators
3.0 mm \pm
4.0 mm \pm
17.0 mm \pm
18.0 mm \pm

Hegar
C-1651
Set of 13 dilators
1.0 mm \pm
2.0 mm \pm
25.0 mm \pm
26.0 mm \pm



UTERINE SOUNDS AND
DEPRESSORS

Surgical
Instruments



Valleix
C-1652
(25 cm)



Braun
C-1653
(28 cm)



C-1654
Uterine probe



Sims
C-1855
C-1656
(32 cm)



C-1657
C-1658
(32 cm)



CERVICAL BIOPSY AND SPECIMEN FORCEPS



Kevorkian
C-1659
(24.5 cm)
shaft

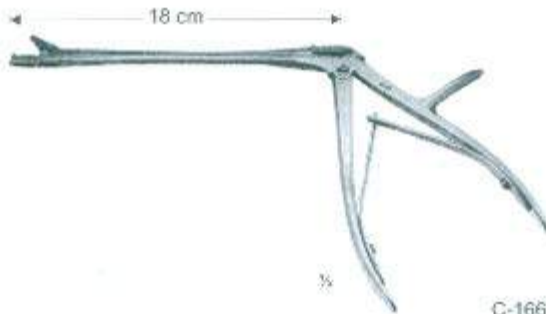

C-1660
(18 cm)
shaft

EAR POLYPUS SNARES
EAR DRESSING FORCEPS

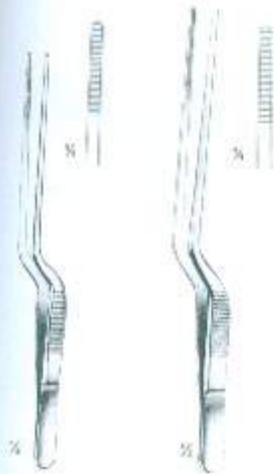

Lucae
C-1661
(14 cm)

Jansen
C-1662 (16 cm)
C-1663 (20 cm)



Troeltsch (Wilde)
C-1664
(11 cm)

Troeltsch (Wilde)
C-1665
(12 cm)

Troeltsch (Wilde)
C-1666
(13 cm)

Steel wire Loops for ear snares, pre-shaped
in bundles of dozen each



C-1667
0.2 mm

Steel Wire for ear snares



10mm/3/8 in

C-1668
0.3 mm
C-1669
0.4 mm



Krause
C-1670
(16 cm)

Krause-Voss
C-1671
(16 cm)

EAR POLYPUS FORCEPS

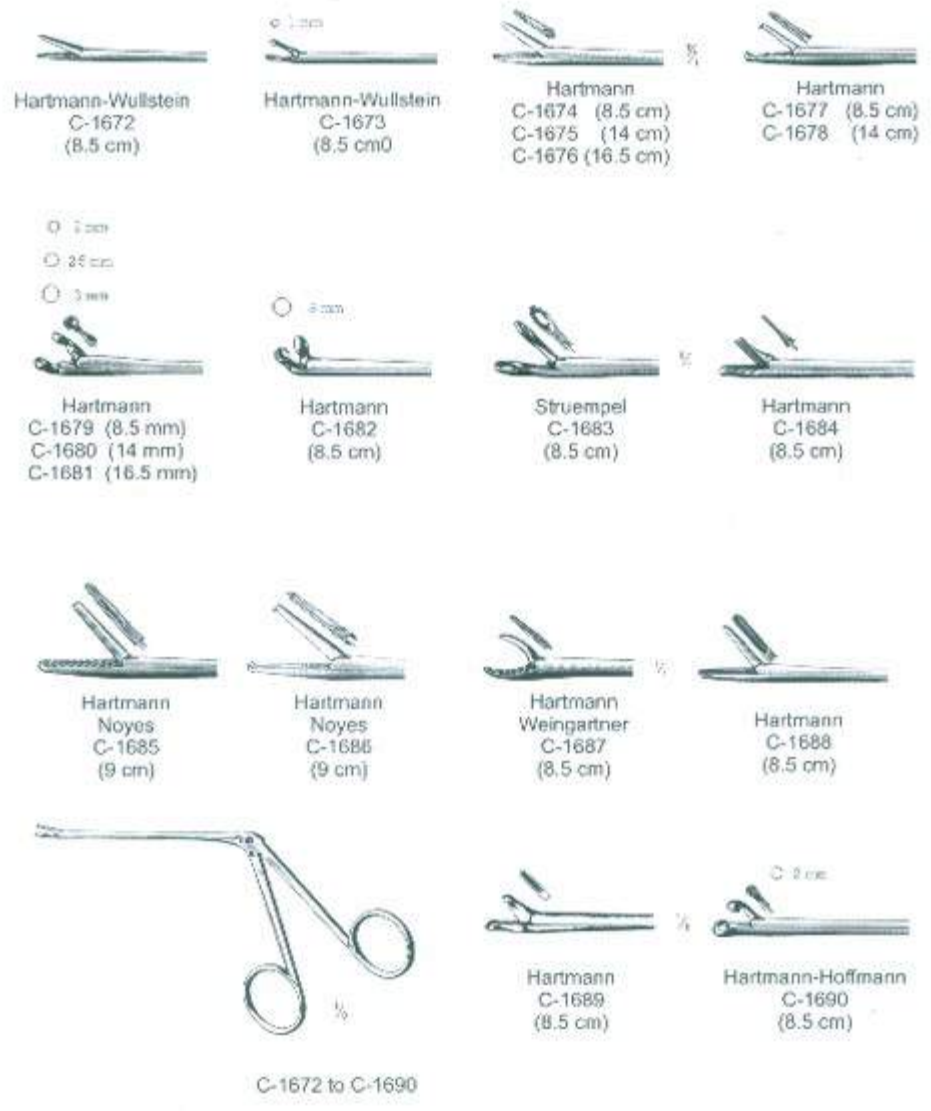

PUNCHES AND CURTETTES



Citelli
C-1691



Boyer
C-1692



Boyer
C-1693



Langenbeck
C-1694
(13 cm)



Shapleigh
C-1695
to
C-1698



C-1695



C-1696



C-1697



C-1698



Coxeter
C-1699
(15 cm)
Bunt



NASAL SPECULA

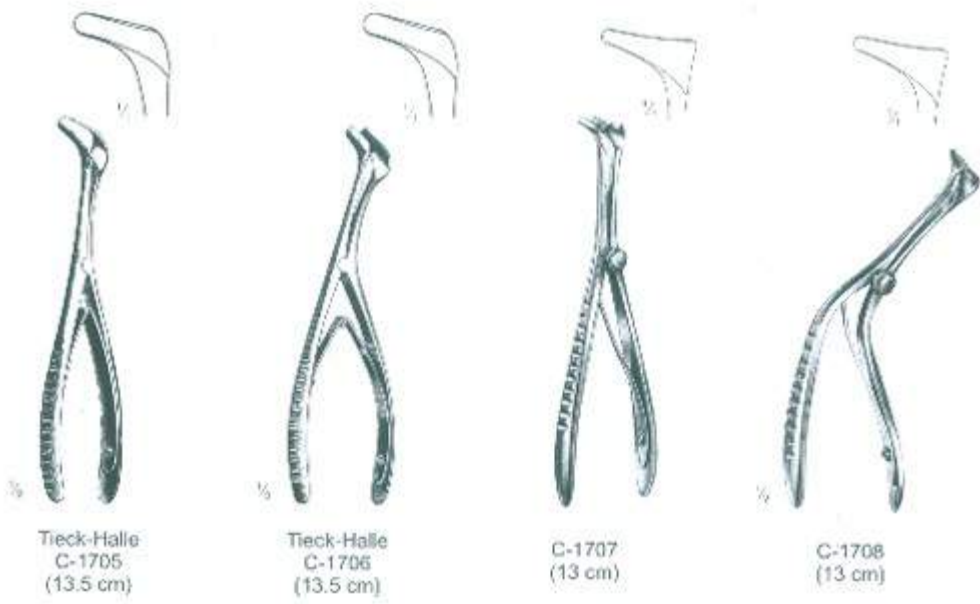
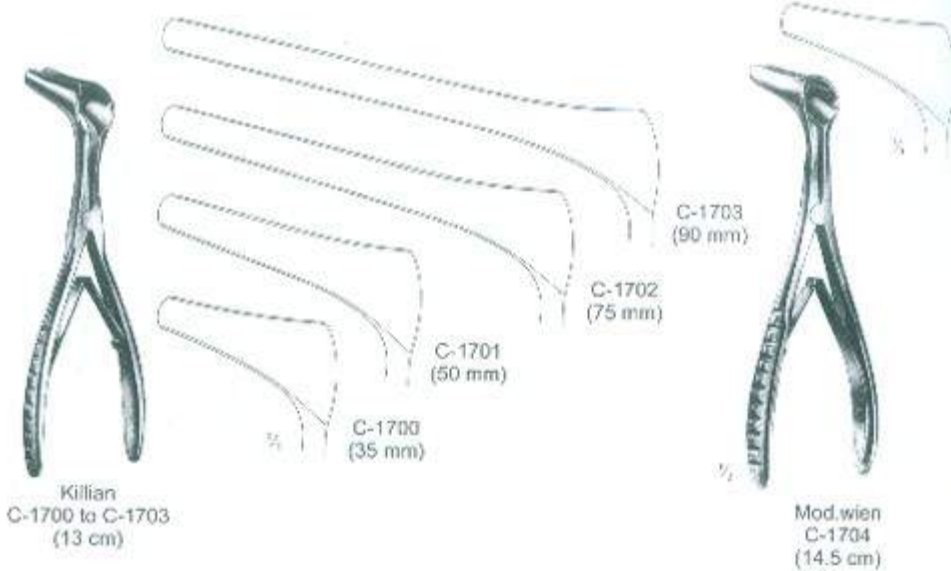

SEPTUM COMPRESSION FORCEPS

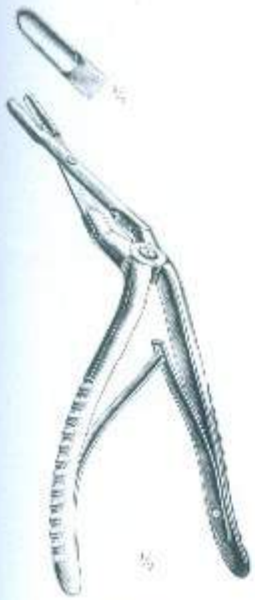

Middleton-Jansen
C-1709
(19 cm)



Middleton-Jansen
C-1710
(19 cm)



Jansen-Struycken
C-1711
(19 cm)



SPHENOID PUNCHES
ANTRUM PUNCH FORCEPS



4 x 4 mm	5 x 5 mm	6 x 6 mm
		
C-1712 (4 mm)	C-1713 (5 mm)	C-1714 (6 mm)



Kerrison
C-1712 to C-1714
(20 cm)



Hajek-Claus
C-1715
(20 cm)

RHINOPLASTIC INSTRUMENTS



Aufricht
C-1716
(19 cm)



Freer
C-1717
(15 cm)



Kilner
C-1718
(10 cm)



Converse
C-1719
(12 cm)



Fomon
C-1720
(17 cm)



Lange
C-1721
(22 cm)



Joseph
C-1722
(15 cm)



Cottle
C-1723
(16 cm)



C-1724 to C-1726
(15 cm)



C-1724



C-1725



C-1726

RHINOPLASTIC INSTRUMENTS

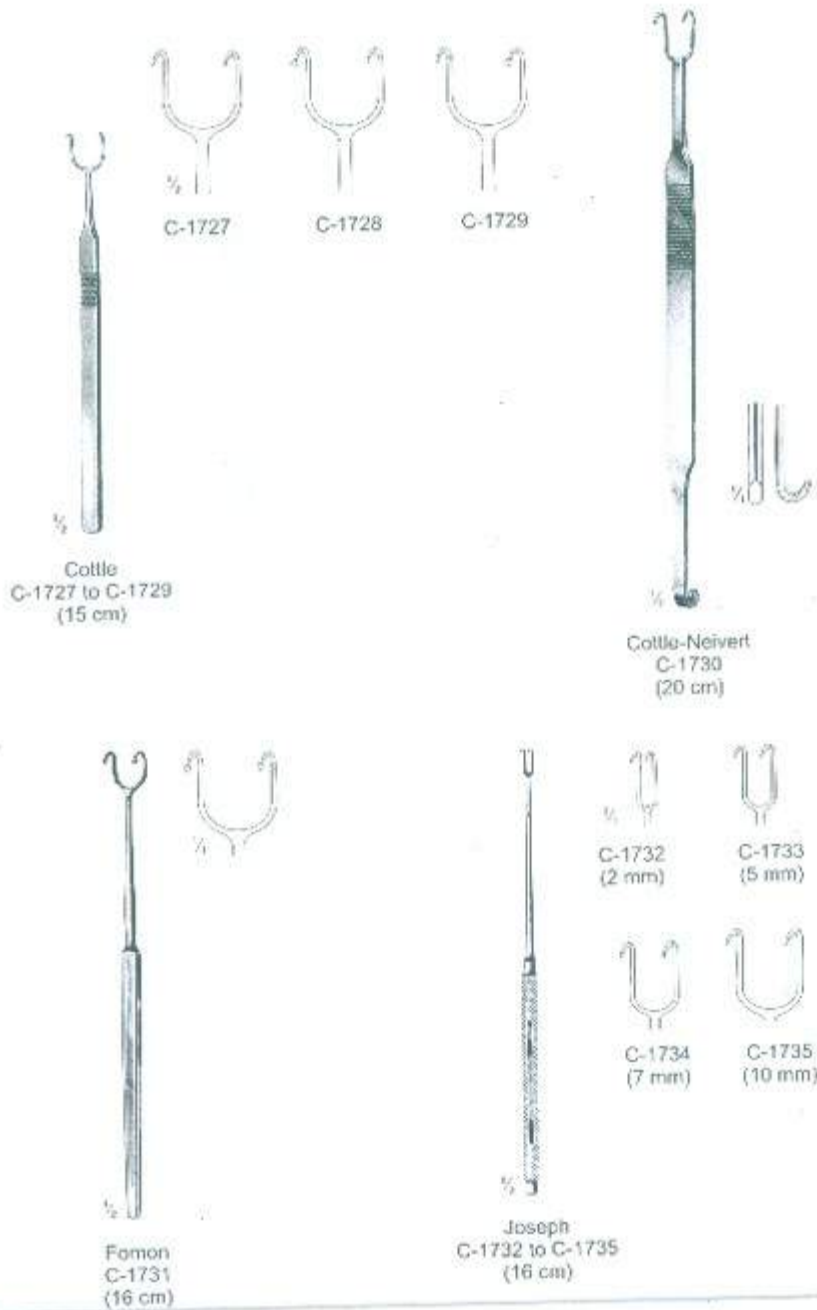

RHINOPLASTIC INSTRUMENTS



Asch
C-1736
(23 cm)



Kressner
C-1737
(20 cm)



C-1738



C-1739



C-1740

Cottle-Walsham
C-1738 to C-1740
(23 cm)



MOUTH GAGS



Molt
C-1741
(14 cm)



Molt
C-1742
(11 cm)



Denhart
C-1743
(12 cm)



Roser-Konig
C-1744 (16 cm)
C-1745 (19 cm)



Heister
C-1746
(13 cm)

CHEEK AND LIP RETRACOTRS
TONGUE DEPRESSORS

Surgical
Instrument



Sternberg
C-1747 (14 cm)
C-1748 (16 cm)
C-1749 (18 cm)



Sternberg
C-1750 (12 cm)
C-1751 (14 cm)
C-1752 (16 cm)



Wieder
C-1753 to C-1754



C-1753
(14 cm)



C-1754
(15 cm)



Andrew
C-1755
(11 cm)



Tobold
C-1756
(14 cm)



Hartmann
C-1757
(15 cm)



Tobold
C-1758
(14 cm)



Mortiz-Schmidt
C-1759
(19 cm)



TONGUE HOLDING
FORCEPS

Surgical
Instruments



Young
C-1760
(17 cm)



Guy
C-1761
(19 cm)



Collin
C-1762
(17 cm)

TONSIL SNARES

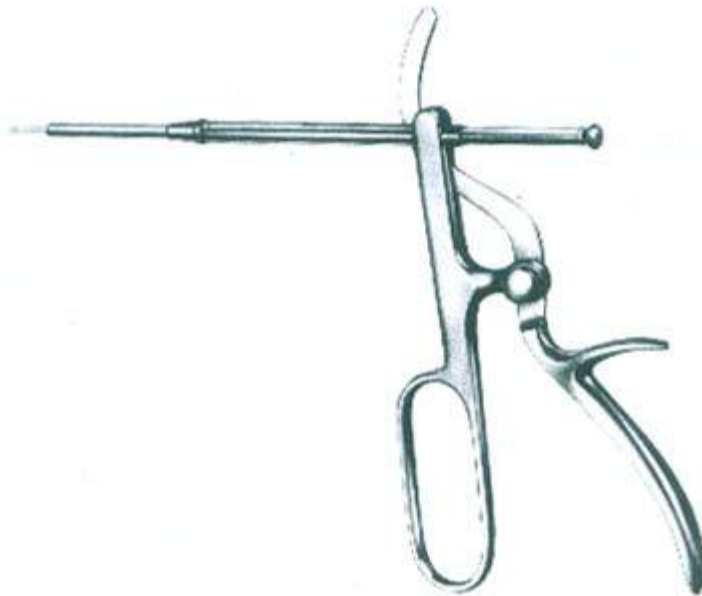

Tying
C-1783
With 1 straight tip

BRONCHO-ESOPHAGOSCOPY FORCEPS
LARYNGEAL POLYPUS FORCEPS, EPIGLOTTIS RETRACTOR

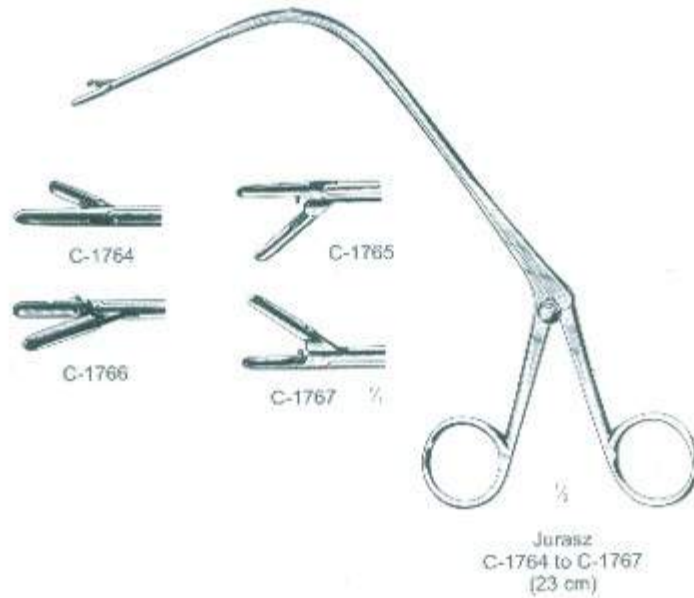

Cm	Inch			
30	12	C-1768	C-1772	C-1776
40	16	C-1769	C-1773	C-1777
50	20	C-1770	C-1774	C-1778
60	24	C-1771	C-1775	C-1779

Chevalier-Jackson
C-1768 to C-1795

Cm	Inch				
30	12	C-1780	C-1784	C-1788	C-1792
40	16	C-1781	C-1785	C-1789	C-1793
50	20	C-1782	C-1786	C-1790	C-1794
60	24	C-1783	C-1787	C-1791	C-1795

STERILIZING FORCEPS



Cheate
C-1796
(27 cm)
Sterilizing forceps.



Pye-Smith (Harrison)
C-1797
(30 cm)



C-1798
(30 cm)



Rogge
C-1799
(23 cm)

DISSECTING FORCEPS

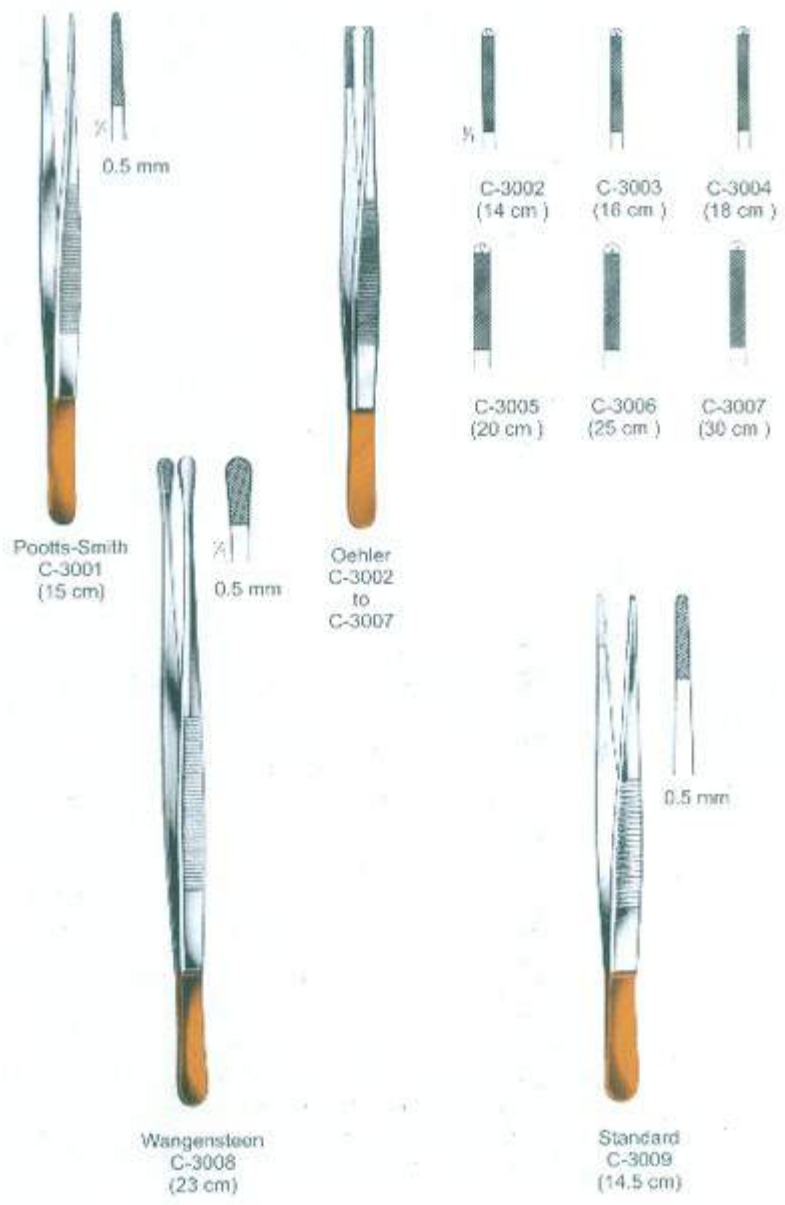



NEEDLE HOLDERS



Kilner
C-3010
(13.5 cm)

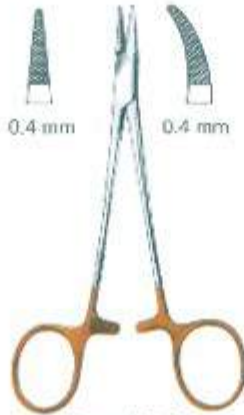

Crilewood-Baby
C-3011
(15 cm)

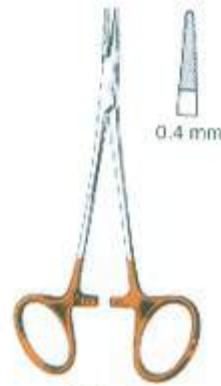

Neivert
C-3012
(13 cm)

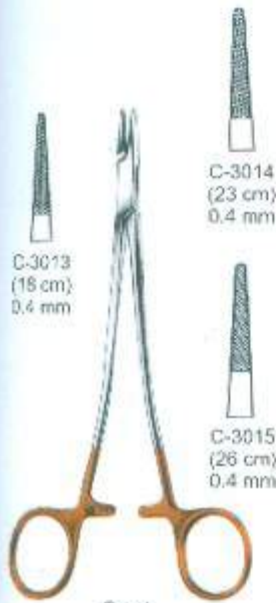

Sarot
C-3013
to
C-3015



Micro-Vascular
C-3016
(15 cm)

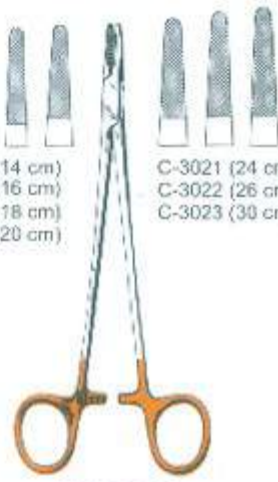

Mayo-Hegar
C-3017
to
C-3023

C-3013
(18 cm)
0.4 mm

C-3014
(23 cm)
0.4 mm

C-3015
(26 cm)
0.4 mm

0.2 mm

C-3017 (14 cm)
C-3018 (16 cm)
C-3019 (18 cm)
C-3020 (20 cm)

C-3021 (24 cm)
C-3022 (26 cm)
C-3023 (30 cm)



NEEDLE HOLDERS

T.C
Instruments



NEEDLE HOLDERS



0.5 mm
C-3034
(20cm)

0.5 mm
C-3035
(25cm)

C-3034
to
C-3035



0.5 mm
C-3036
(20cm)

0.5 mm
C-3037
(23cm)

Zwiefel
C-3036
to
C-3037



0.5 mm

Mathieu
C-3038
(20cm)



0.5 mm
C-3039
(14cm)
C-3040
(17cm)
C-3041
(20cm)

Mathieu
C-3039
to
C-3041



0.5 mm
C-3042
(17cm)
C-3043
(20cm)

Mathieu
C-3042
to
C-3043



0.5 mm

Hosel
C-3044
(25cm)



MICRO NEEDLE HOLDERS

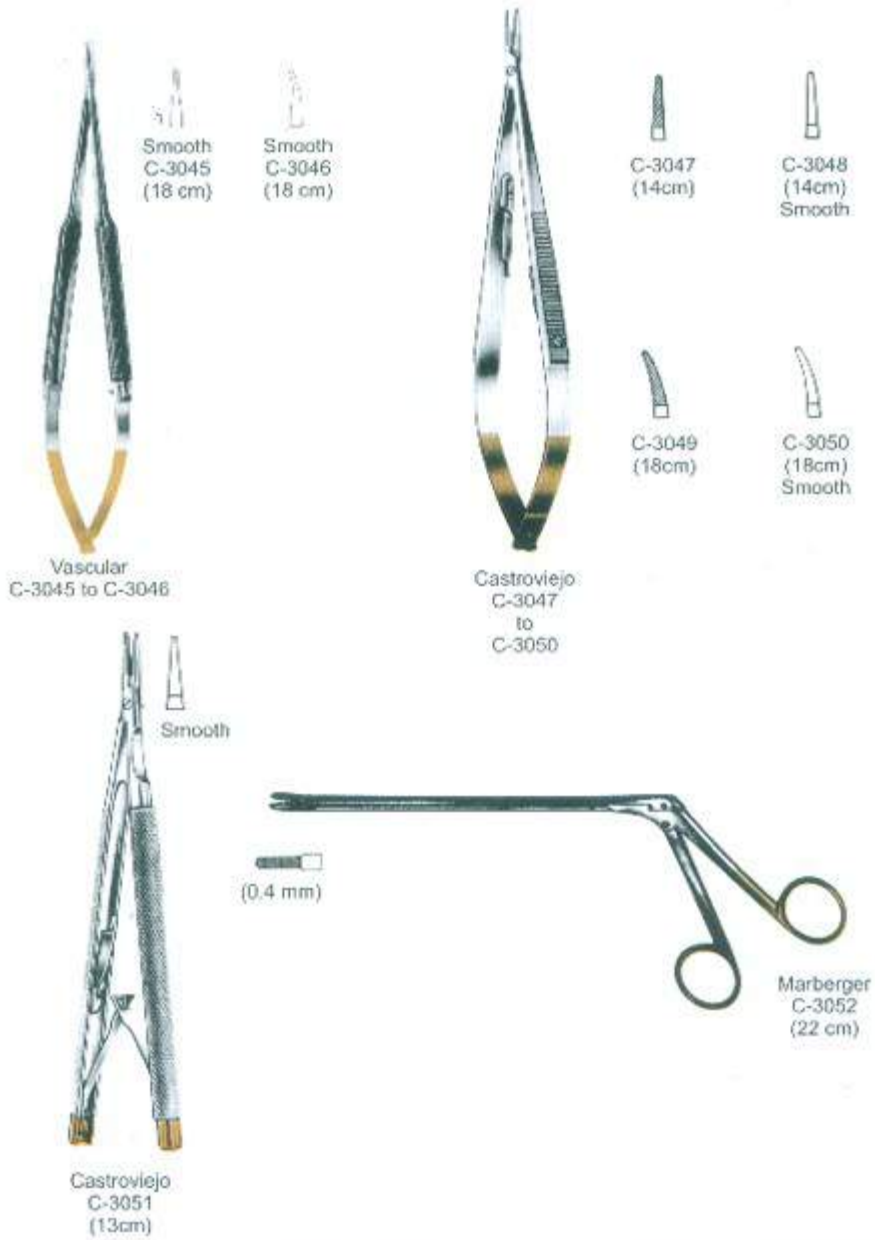



OPERATING SCISSORS

T.C.
Instruments



C-3053
(14.5 cm)
B/B Cur



Standard
C-3054
(14.5 cm)
S/B Cur

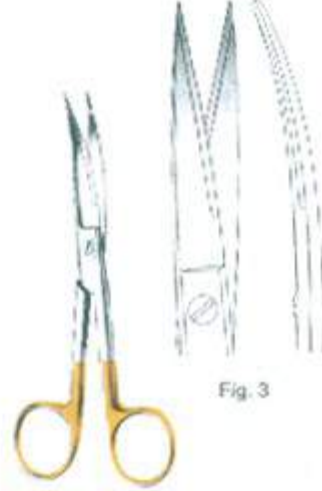

Standard
C-3055
(14.5 cm)
S/S Cur



Standard
C-3056
(14.5 cm)
B/B Str



Standard
C-3057
(14.5 cm)
S/B Str

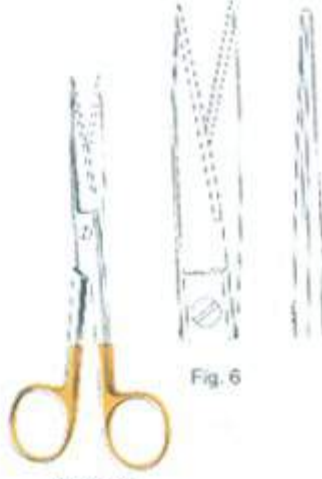

Standard
C-3058
(14.5 cm)
S/S Str



GYNECOLOGICAL AND DISSECTING SCISSORS

T.C.
Instruments

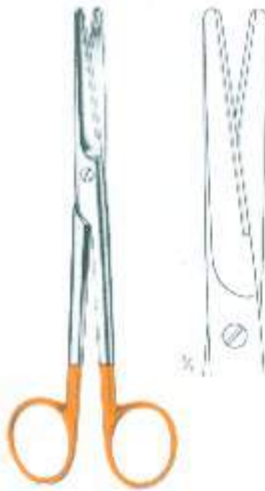

Mayo-Stile
C-3059
(15 cm)



Mayo-Stile
C-3060
(15 cm)



Mayo
C-3061
(15 cm)

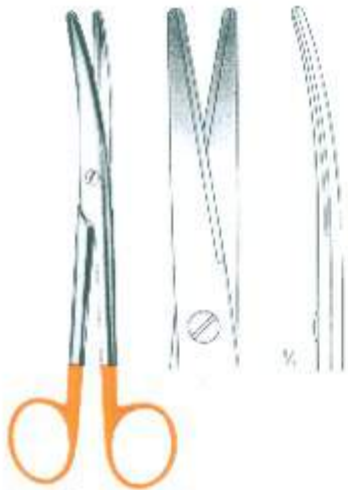

Mayo
C-3062
(15 cm)



Locklin
C-3063
(16.5 cm)

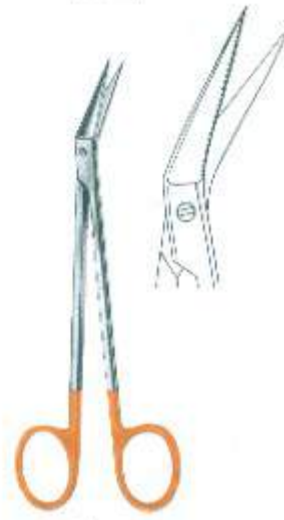

Locklin
C-3064
(16.5 cm)



WIRE TWISTING FORCEPS



C-3065
(140 mm)



Sternum
C-3066
to
C-3067

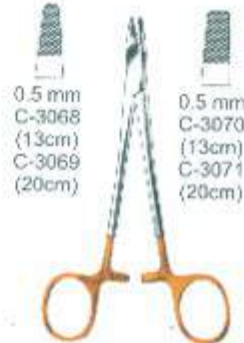

C-3068
to
C-3071



C-3072
(20 cm)



C-3073
(18 cm)



BONE CUTTING FORCEPS

T.C.
Instruments

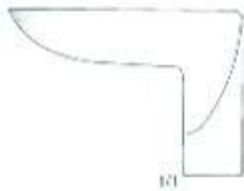

1/1



C-2075
(23 cm)

C-2076
(27 cm)



1/2

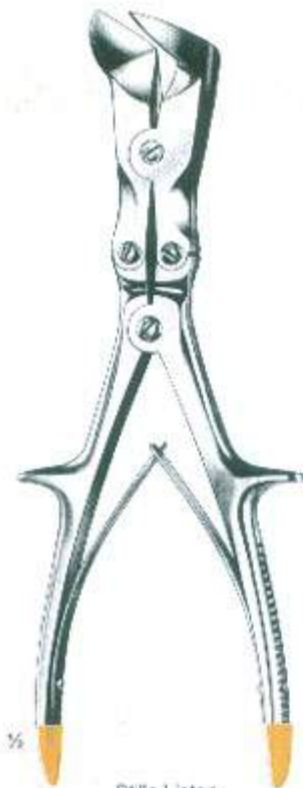

1/2

Stille Liston
C-3074
(27 cm)

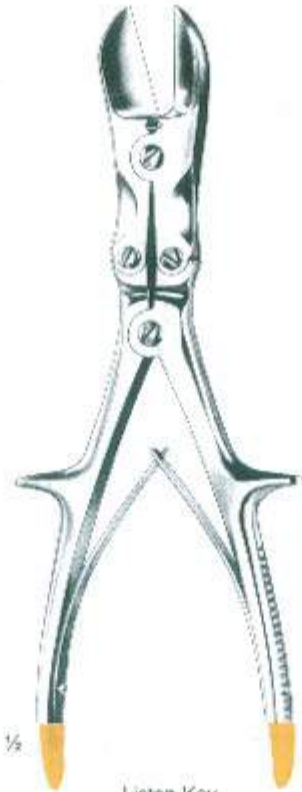

1/2

Liston-Key
C-3075
to
C-3076



1/2

Stille Liston
C-3077
(27 cm)



EXTRACTING FORCEPS

T.C.
Instruments



1
C-3078



C-3079



99
C-3080

ALPHABATICAL

INDEX

SURGICAL INSTRUMENTS
T.C. INSTRUMENTS
DENTAL INSTRUMENTS



ALPHABETICAL

SURGICAL INDEX		CRILE (Needle Holders)	35
A			
ADSON (Artery Forceps)	15	CRILE-MURRAY (Needle Holders)	33
ADSON (Dressing Forceps)	11	CUSCO (Vaginal Specula)	58
ADSON (Needle Holders)	33	CROWN (Gum Scissors)	9
ADSON (Retractors)	26	D	
ADSON (Suction Tubes)	30	DEAVER (Retractors)	25
ALEXANDER (Pericostal Raspatories)	42	DEMEL (Bone Wire Tighteners)	40
ALLIS (Tissue And Organ Holding Forceps)	53	DENHART (Mouth Gags)	70
ALLIS-ADAIR (Tissue And Organ Holding Forceps)	53	DERF (Micro, Needle Holder)	32
ALLIS-BABY (Tissue And Organ Holding Forceps)	53	DESMARRES (RETRACTOR)	21
ANDREW (Tongue Depressors)	71	DOYEN (RETRACTOR)	24
ARRUGA (Micro, Needle Holders)	32	DUVAL (Tissue And Organ Holding Forceps)	54
ASCH (Rhinoplastic Instruments)	69	Dressing Forceps (Standard)	11
AUFRIEHT (Nasal Retractor)	57	E	
		ECHLIN (Bone Rongeur Forceps)	48
		ENGEL (Saw)	38
		ESMARCH (Knives)	38
B		F	
BABCOCK (Tissue And Organ Holding Forceps)	54	FARABEUF (Pericostal Raspatories)	42
BABY-MIXTER (Artery Forceps)	14	FOERSTER (Sponge Holding)	19, 18
BACKHAUS (Towel Forceps)	17	FOMON (Rhinoplastic Instruments)	57, 58
BAFLOUR (Abdominal Retractor)	29	FRAZIER (Suction Tubes)	30
BALFOUR-BABY (Abdominal Retractor)	29	FREER (Skin Hook)	67
BARR (Rectal Specula)	55	G	
BENNETT (Bone Levers)	43	GELPI-LOKITE (Retractor)	27
BEYER (Bone Rongeur Forceps)	47	GERSTER-LOWMANN (Bone Holding Clamps)	39
BEYER (Punches)	63	GILLIES (Needle Holders)	35
BLOUNT (Bone Levers)	43	GILLIES (Tissue Forceps)	12
BLUMENTHAL (Bone Rongeur Forceps)	47	GOSSET (Abdominal Retractor)	28
BOHLER (Bone Rongeur Forceps)	47	GRIFI-SEILETZ (Retractor)	27
BOHLER (Extension Bows)	40	GRAEFFE (Retractors)	20
BOYS-ALLIS (Tissue And Organ Holding Forceps)	53	GRAVES (Vaginal Specula)	56
BOZEMANN-DOUGLAS (Uterine Polypus)	18	GRAZIL (Operating Scissors)	3
BRAUN (Uterine Sounds)	59	GUY (Tongue Holding Forceps)	72
BROWN (Needle Holders)	33	GUTHRIE (Retractors)	20
BRUNS (Plaster Shears)	37	H	
BUCK (Ligature Scissors)	9	HOHMANN (Bone Lever)	43
BALFOUR (Abdominal Retractors)	29	HAJEK-CLAUS (Spinal Punches And/or Punch Forceps)	86
BUSCH (Junctional Scissors)	10	HALSEY (Needle Holders)	33
C		HALSTED-MOSQUITO (Artery Forceps)	13
CAMPBELL (Micro, Needle Holders)	36	HARTMANN (Artery Forceps)	14
CASTROVIEJO (Micro, Needle Holders)	32	HARTMANN (Bone Rongeur Forceps)	45
CHEATLE (Sterilizing Forceps)	75	HARTMANN (Ear Polypus Forceps)	62
CHEVALIER-JACKSON (Gracho-Esophagostomy Forceps)	74	HARTMANN (Tongue Depressors)	71
CHARRIERE (Amputating & Resection Saws)	39	HARTMANN-HOFFMANN (Ear Polypus Forceps)	62
CITELLI (Punches)	63	HARTMANN-WULLSTEIN (Ear Polypus Forceps)	62
CLEVELAND (Bone Rongeur Forceps)	46	HEANEY (Needle Holders)	34
CLOWARD (Lamina Spreaders)	52	HEGAR-BAUMGARTNER (Needle Holders)	33
COLLIER (Needle Holder)	32	HEISTER (Mouth Gags)	70
COLLIN (Tissue Organ Holding Forceps)	50	HENNEY (Hysterectomy Forceps)	16
COLLIN (Tongue Holding Forceps)	72	HENNIG (Plaster Spreaders)	38
COLLIN (Vaginal Specula)	58	HIBBS (Bone chisels And Gouges)	41
COLLIN-LOKITE (Abdominal Retractor)	28	HIRSCHMANN (Rectal Specula)	55
CONVERSE (Rhinoplastic Instruments)	67	HOPKINS (Knives)	38
COTTLE (Rhinoplastic Instruments)	67, 68	HEGER (Uterine Dilators)	58
COTTLE-NEIVERT (Rhinoplastic Instruments)	68	I	
COTTLE-WALSHAM (Rhinoplastic Instruments)	69	ISRAEL (Retractors)	22
COXETER (Curettes)	53	INGE (Lamina Spreaders)	52
CRILE (Artery Forceps)	13		

J		MEAD (Bone Rongeur Forceps)	46
JACKSON (Vagina Specula)	57	METZENBAUM (Dissecting Scissors)	5
JAMISON (Needle Holders)	34	METZENBAUM (Needle Holders)	33
JANSEN (Ear Dressing Forceps)	61	METZENBAUM (Operating And Dissecting Scissors)	5
JANSEN-STRUYCKEN (Septum Compression Forceps)	65	METZENBAUM-NELSON (Dissecting Scissors)	6
JOSEPH (Dissecting And Fine Operating Scissors)	7	MIDDLETON-JANSEN (Septum Compression Forceps)	65
JOSEPH (Rhino-lastic Instruments)	67-68	MINI-LANGENBACK (Retractor)	21
JURASZ (Laryngeal Forceps)	74	MIXTER (Artery Forceps)	16
K		MOD-WIEN (Nasal Specula)	64
KELLY (Artery Forceps)	14	MOLLISON (Retractor)	28
KELLY (Operating And Dissecting Scissors)	5	MOLT (Mouth Gags)	73
KELLY (Rectal Specula)	55	MORTIZ-SCHMIDT (Tongue Depressors)	71
KELLY (Retractors)	23	MOSQUITO (Artery Forceps)	13
KELLY-RANKIN (Artery Forceps)	14	N	
KERN (Bone Holding Forceps)	44	NEIVERT (Needle Holders)	33
KERRISON (Special Pincers Antium Parot. Forceps)	66	NEUMANN (Gum Scissors)	9
KEVORKIAN (Cervical Biopsy And Specimen Forceps)	60	NEWMAN (Rectal Specula)	55
KILLIAN (Nasal Specula)	64	O	
KILNER (Dissecting And Fine Operating Scissors)	7	OCHSNER (Trocars)	30
KILNER (Skin Hook)	67	OLIVECRONA-TOENNIS (Clips Applying Forceps)	51
KIRSCHNER (Bone Wire Tighteners)	40	OLSLIN-HEGAR (Needle Holders)	35
KOCHER (Retractors)	24	OPERATING SCISSORS (Standard)	02-03
KRAUSE (Ear Polypus Snare)	61	P	
KRAUSE-VOSS (Ear Polypus Snare)	61	PARTSCH (Mallets)	41
KRESSNER (Rhino-lastic Instruments)	69	PENNINGTON (Tissue Organ Holding Forceps)	53
KRISTELLER (Vaginal Specula)	57	POOLE (Suction Tubes)	30
L		PEAN (Artery Forceps)	15
LANE (Bone Holding Forceps)	45	PYE-SMITH (Sterilizing Forceps)	75
LANGE (Rhino-lastic Instruments)	67	POOTS-SMITH (Dissecting Forceps)	76
LANGENBACK (Elevators)	41	Q	
LANGENBACK (Retractor)	22	QUINBY (Gum Scissors)	8
LANGENBECK (Bone Holding Forceps)	44	R	
LANGENBECK (Curettes)	63	RANEY (Clips Applying Forceps)	51
LEXER-BABY (Dissecting And Fine Operating Scissors)	7	RANKIN CRILE (Artery Forceps)	13
LICHTENBERG (Needle Holders)	36	REINER (Knives)	38
LITTON KEY (Bone Cutting Forceps)	49	RAMPLEY (Sponge Holding)	19
LITTAURE (Ligature Scissors)	9	R-CARD (Abdominal Retractor)	29
LISTER (Bandage Scissors)	37	RICHARDSON (RETRACTOR)	23
LINGE (Lamina Spreaders)	52	RICHARDSON-EASTMANN (Retractor)	23
LUTE (Bone Wire Tighteners Extension Bows)	40	ROEDER (Towel Forceps)	17
LOVELACE (Tissue Organ Holding Forceps)	50	ROGGE (Sterilizing Forceps)	75
LSRAEL (Retractor)	22	ROSER-KONIG (Mouth Gags)	70
LUCAE (Ear Dressing Forceps)	61	ROCHESTER OCHSNER (Artery Forceps)	15
M		ROCHESTER PEAN (Artery Forceps)	15
MAGILL (Catheter Forceps)	31	RUSKIN (Bone Rongeur Forceps)	47, 48
MARQUARDT (Bone Rongeur Forceps)	47	S	
VASSON (Needle Holders)	34	SAKURAS (Vaginal Specula)	56
MATHIEU (Micro, Needle Holders)	36	SATTERLES (Amputating & Resection Saws)	39
MATHIEU (Rectal Specula)	55	SCHAEDEL (Towel Forceps)	17
MAYFIELD (Bone Rongeur Forceps)	47	SCHUHMACHER (Unipolar Scissors)	10
MAYO NOBLE (Gynecological Scissors)	4	SEMB (Bone Holding Forceps)	44
MAYO-HARRINGTON (Gynecological Scissors)	4	SEMB (Bone Rongeur Forceps)	48
MAYO-HEGAR (Needle Holders)	34	SEMKEN (Dressing Forceps)	11
MAYO-STILLE (Gynecological Scissors)	4	SHAPLEIGH (Curettes)	63
MCINDOE (Dressing Forceps)	11	SIMM (Vaginal Specula)	57
MCKENZIE (Clips Applying Forceps)	51	SIMS (Operating And Dissecting Scissors)	5
MCINTOSH (Laryngoscope)	31	SIMS (Uterine Sounds)	59
MEAD (Mallets)	41	SPENCER (Ligature Scissors)	9

SPENCER-WELLS (Artery Forceps)	14
SCALPLE HANDLES (Standard)	1
STELLBRINK	46
STERNBERG (Cheek And Lip Retractors)	71
STILLE (Plaster Snare)	37
STILLE (Bone Rongeur Forceps)	48
STILLE (Tissue Forceps)	12
STILLE-LISTON (Bone Cutting Forceps)	49
STRATTE (Needle Holders)	35
STRUENPEL (Ear PolyPlus Forceps)	62
T	
TAYLOR (Dressing Forceps)	11
TISSUE FORCEPS (Standard)	12
TIECK-HALLE (Nasal Specula)	64
TOBOLD (Tongue Depressors)	71
TOENNIS (Needle Holders)	36
TOHOKU (Towel Forceps)	17
TROELTSCH (Ear Dressing Forceps)	61
TUFFER (Retractor)	24
TYDING (Tonsil Snare)	73
U	
UNIVERSAL (Bone Rongeur Forceps)	46
UNIVERSAL (Wire Cutting Scissors)	9
UTERINE PROP (Uterine Sounds And Depressors)	59
UMBILICAL SCISSORS (U.S. Mode)	10
UTILITY (Bandage and clothing scissors)	37
UTERINE DILATORS	58
V	
VALLEIX (Uterine Sounds)	59
W	
WEBSTER (Needle Holders)	32
WEITLANER-WULLSTEIN (Retractor)	26
WERTHEIM (Gynecological Scissors)	4
WESTCOTT (Micro Scissors)	8
WIEDER (Tongue Depressors)	71
WOLFF (Plaster Cast Instruments)	38
Y	
YANKAUER (Suction Tubes)	30
YOUNG (Tongue Holding Forceps)	72
Z	
ZAUFAL-JANSEN (Bone Rongeur Forceps)	47

ALPHABETICAL

TC. INDEX

B	
BARRAQUER (Needle Holders)	
BAUMGARTNER (Needle Holders)	
C	
CASTROVIEJO (Micro Needle Holders)	
CONVERSE (Needle Holders)	
CRILEWOOD-BADY (Needle Holders)	
D	
DISSECTING FORCEPS (Standard)	
DERF (Needle Holders)	
E	
EXTRACTING FORCEPS	
G	
GILLIES (Needle Holders)	
H	
HOSSEL (Needle Holders)	
J	
JACOBSON (Needle Holders)	
K	
KILNER (Needle Holders)	
L	
LISTON-KEY (Bone Cutting Forceps)	
LOCKLIN (Gynecological and Dissecting Scissors)	
M	
MARBERGER (Micro Needle Holders)	
MATHIEU (Needle Holders)	
MAYO (Gynecological and Dissecting Scissors)	
MAYO-HEGAR (Needle Holders)	
MAYO-STILE (Gynecological and Dissecting Scissors)	
MICRO-VASCULAR (Needle Holders)	
N	
NEIVERT (Needle Holders)	
O	
OEHLER (Dissecting Forceps)	
OISEN-HEGAR (Needle Holders)	
OPERATING SCISSORS	
P	
POOTTS-SMITH (Dissecting Forceps)	
S	
SAROT (Needle Holders)	
STERNUM (Wire Twisting Forceps)	
STILLE-LISTON (Bone Cutting Forceps)	
V	
VASCULAR (Micro needle Holders)	
W	
WANGENSTEEN (Dissecting Forceps)	
Z	
ZWEIFEL (Needle Holders)	



www.chandjee.com.pk